



Service Catalog 2021

Date 19/01/2021

ENGINEERING YOUR SUCCESS.



Service Catalog 2021

False economy, can cost you dearly!

Those who follow a set of simple but effective maintenance rules carry out preventative maintenance of their compressed air dryer on a rolling 12-month basis. To prevent premature wear of other downstream components, nearly pre-and after-filter-elements, silencers and pilot-valves need replacing.

On a 24 month basis, individual dryer sizes also require a replacement of their main control-valves and non-return valves.

Where 12 and 24 month maintenance regimes are strictly adhered to, general overhaul of the dryer should be carried out after 48 months of operation. Together with parts which are generally replaced annually or bi-annually, the by now exhausted adsorption material including seals must be replaced. On some dryer sizes, the flow distributor should also be replaced.

Following this, the above mentioned and customary maintenance regime re-commences, thus preserving the users original capital outlay.



The service-package we offer consists of a tailor-made spare-parts program with which preventative maintenance work can be carried out inexpensively. During the formulation of these service packages, great care and attention was paid particularly to the choice of the parts required. Maintenance intervals have been calculated in such a way, to ensure that despite heavy demands made on frequently operated parts, these still continue to exhibit their optimum service life. In this way, the execution of regular maintenance means that stoppages are prevented before they occur. The use of service-kits avoids downtime losses.

Should plant shutdown actually happen, this can be a costly occurrence, not to mention the subsequent impact of having to restore operations. By using genuine original spare-parts users are establishing an optimum level of all-round protection, which enables them to safely run their systems at full capacity without fear of component breakdown. This approach saves money. The service packages themselves represent an inexpensive preventative tool, cheaper overall than the sum of their component parts. Ordering the right Service-kit couldn't be easier.

Attention!

This Service Catalogue refers only to Parker Zander standard manufactured dryer units. For special project fabricated dryers the parts can vary and deviate. If further support is needed in case of special project dryers maintenance please contact your local Parker Sales Company.

But how is it possible to differ between standard dryer or special project dryer?

One look to the nameplate of the dryer is enough to identify

Nameplate example standard dryer:



Nameplate example special project dryer with -00x at the end of product code:



Adsorption Dryers

WVM Concept Series

7

Generation 5 WVM 45-1450 Series from 01/2021 to the present day	8
Generation 4 WVM 40-1450 Series from 5/2012 to 12/2020	10
Generation 3 WVM 40-1450 Series from 4/2009 to 4/2012	12
Generation 2 WVM 40-1450 Series from 2007 to 4/2009	14
Generation 1 WVM 40-1450 Series from 2000 to 2006	16

Heatless Adsorption Dryers

Adsorption Dryers ecodry K-MT 1-4, K-MT 1- 8, KM 5-115 Series

19

Generation 3 K-MT 1-8 (OIL-X fi lter) Series from 1/2019 to the present day	20
Generation 2 K-MT 1-8 Series from 7/2011 to 12/2018	22
Generation 1 K-MT 1-8 Series from 5/2003 to 4/2011	24
Generation 0 KM 5-115 Series up to mind 2003	26

Adsorption Dryers ecodry K-MT 45-95, K-MT 10-95, KE-MT 10-95, KEN-MT Series

29

Generation 3 K-MT 10-95 (OIL-X fi lter) Series from 1/2019 to the present day	30
Generation 2 K-MT 10-95 Series from 7/2011 to 12/2018	32
Generation 1 KE-MT 10-95 Series from 4/2007 to 7/2011	34
Generation 0 KEN-MT 200-1400 Series from 5/2003 to 4/2007	36
Generation -1 KEN 200-1400 Series from 9/2001 to 5/2003	38
Generation 1B KE-MT 120-600 Series from 4/2007 to the present day	40
Generation 1A KEN-MT 2000-10000 Series from 3/2003 to 4/2007	42
Generation 0 KEN 2000-10000 Series from 9/2001 to 9/2003	44

Adsorption Dryers ecodry KA-MT 1-4, KA-MT 1- 8, KMA 5-115 Series

47

Generation 3 KA-MT 1-8 (OIL-X fi lter) Series from 1/2019 to the present day	48
Generation 2 KA-MT 1-8 Series from 7/2011 to 12/2018	50
Generation 1 KA-MT 1-8 Series from 5/2003 to 6/2011	52
Generation 0 KMA 5-115 Series up to mind 2003	54

Adsorption Dryers ecodry KA-MT 45-95, KA-MT 10- 95, KEA 10-95, KEA 200-1400

57

Generation 3 KA-MT 10-95 (OIL-X fi lter) Series from 1/2019 to the present day	58
Generation 2 KA-MT 10-95 Series from 7/2011 to 12/2018	60
Generation 1 KEA-MT 10-95 Series from 4/2007 to 7/2011	62
Generation 0 KEA-MT 200-1400 Series from 5/2003 to 4/2007	64

Breathing Air Systems BSP-MT1-8, BS(P)-MT1-8, BS(P) 5-115 Series

67

Generation 3 BSP-MT 1-8 (OIL-X fi lter) Series from 1/2019 to the present day	68
Generation 2 BSP-MT 1-8 Series from 7/2011 to 12/2018	70
Generation 1 BS(P)-MT 1-8 Series from 4/2007 to 6/2011	72
Generation 0 BS(P) 5-115 Series up to mid. 5/2003	74

Breathing Air Systems BSP-MT10-95, BS(P)-MT10-95, BS(P) 200-1400 Series

77

Generation 3 BSP-MT 10-95 (OIL-X fi lter) Series from 1/2019 to the present day	78
Generation 2 BSP-MT 10-95 Series from 7/2011 to 12/2018	80
Generation 1 BS(P)-MT 10-95 Series from 4/2007 to 7/2011	82
Generation 0 BS(P)-MT 200-1400 Series from 4/2005 to 4/2007	84
Generation -1 BS(P)-MT 200-1400 Series from 5/2002 to 4/2005	86

Adsorption Dryers HDK 18/25-550/50, HDK-MT 100 & 350 Series	89
Generation D0 HDK 18/25-550/50 from 2010 to the present day	90
Generation D2 HDK 100 & 350 from 2014 to the present day	92
Accessories D2 HDK 100 & 350 from 2014 to the present day	94
Generation D1 HDK 100 & 350 from 2008 to 2014	98
Controller upgrades	103
Retrofit kits HCDC control	104
Retrofit kits ZDMC2 control	105
Retrofit kits Mutlitronic control	106
Oil-Vapour Adsorbers AK, AKM, AKN Series	107
Generation 3 AKM 1-8 (OIL-X fi lter) Series from 1/2019 to the present day	108
Generation 2 AKM 1-8 Series from 7/2011 to 12/2018	109
Generation 1 AKM 1-8 Series from 4/2007 to 6/2011	110
Generation 0 AKM 5-115 Series up to mid. 7/2003	111
Generation 3 AKM 10-95 (OIL-X fi lter) Series from 1/2019 to the present day	112
Generation 2 AKM 10-95 Series from 7/2011 to 12/2018	113
Generation 1 AK 10-95 Series from 7/2007 to 6/2011	114
Generation 0 AKN 200-1400 Series up to 6/2003	115
Generation 2 AK 120-600 Series, AKN 2000-10000 Series	116
Condensate Drain ED3000 and ED4100 Series	117
System planner for compressed air preparation	118

WVM Concept Series



WVM Concept Series



GENERATION 5

from 4/2020 to the present day

For the maintenance of this product range, 12/36, 24 and 48 month service-kits are required, together with other components referenced below. Furthermore a 48 month maintenance interval requires a DESMIX-package (Adsorption material package) containing all filling-materials, seals and flow-distributor for the dryer model in question. It makes good sense to combine this 48 month inspection period with the periodic inspection requirements of the authorities for pressure vessel safety, where this is market relevant.

12 and 36 month interval

Material required: Service-kit, Pre- and after filter elements, Silencers
 Service-kit contents: Filter elements for control-air.
 Options: Dew-point sensor ZHM100/450.

WVM	Material required – PMC Order No.			Options – PMC Order No.	
Product code	Service-kit	Filter-element	Silencer	Others	
WVM45-1450	SKW45-W1450/VM5/12	See replacement filter elements on opposite page	See table – 48 months	ZHM100/450	

24 month interval

Material required: Service-kit, Pre-and after filter elements, Silencers
 Service-kit contents: Filter elements for control-air, solenoid for pilot valves,
 Options: Dew-point sensor ZHM100/450

WVM	Material required – PMC Order No.			Options – PMC Order No.	
Product code	Service-kit	Filter-element	Silencer	Others	
WVM 45-1450	SKW45-W1450/VM5/24	See replacement filter elements on opposite page	See table – 48 months	ZHM100/450	

48 month interval

Material required: Service-kit, Pre-and after filter elements, DESMIX- package (see oposite), Silencers
 Service-kit contents: Filter elements for control-air, Pneumatic block, expansion valve (V5), pressure build up valve (V4), maintenance parts for the regeneration gas flap (V3), check valve (RV)
 Options: Dew-point sensor ZHM100/450

WVM	Material required – PMC Order No.			Options	
Product code	Service-kit	Filter-element	Silencer	Others	
WVM 45 - 80	SKW45-W80/VM5-E/48	See replacement filter elements on opposite page	1 X SDD-25/AL	ZHM100/450	
WVM 125 - 215	SKW125-W210/VM5-E/48		1 X SDD-25/AL		
WVM 310 – 370	SKW310-W370/VM5-E/48		1 X SDD-25/AL		
WVM 520 - 750	SKW520-W750/VM5-E/48		2 X SDD-25/AL		
WVM 800 – 1080	SKW800-W1080/VM5/48		2 X SDD-25/AL		
WVM 1230 - 1450	SKW1230-W1450/VM5/48		6 X SDD-40/AL		

WVM Concept Series

GENERATION 5
from 4/2020 to the present day



Contents of the DESMIX-package: All filling-materials, Seals and flow-distributor

WVM	PMC Order-No.	WVM	PMC Order-No.	WVM	PMC Order-No.
for Dryer model	DESMIX-package	for Dryer model	DESMIX-package	for Dryer model	DESMIX-package
WVM 45	WVM45DESMIX	WVM 210	WVM210DESMIX	WVM 750	WVM750DESMIX
WVM 60	WVM60DESMIX	WVM 310	WVM310DESMIX	WVM 800	WVM800DESMIX
WVM 80	WVM80DESMIX	WVM 370	WVM370DESMIX	WVM 1080	WVM1080DESMIX
WVM 125	WVM125DESMIX	WVM 520	WVM520DESMIX	WVM 1230	WVM1230DESMIX
WVM 155	WVM155DESMIX	WVM 615	WVM615DESMIX	WVM 1450	WVM1450DESMIX

Additional Spare-parts (Individual parts)

for Dryer model	PMC Order-No.	N°	Scope of supply	for Dryer model	PMC Order-No.	N°
WVM 45 - 80	RKSCD-F50/16/VA	2	Flow-distributor at vessel outlet	WVM 45	ET-ERC-W0045/VM5	Heater electric contactor
WVM 125 - 210	RKSCD-F80/16/VA	2	Flow-distributor at vessel outlet	WVM 60 - 80	ET-ERC-W0080/VM5	
WVM 310 - 370	RKSCD-F100/16/VA	2	Flow-distributor at vessel outlet	WVM 125 - 210	ET-ERC-W0155/VM5	
WVM 520 - 750	RKSCD-F150/16/VA	2	Flow-distributor at vessel outlet	WVM 210 - 370	ET-ERC-W0370/VM5	
WVM 800 - 1080	RKSCD-F200/16/VA	2	Flow-distributor at vessel outlet	WVM 520 - 750	ET-ERC-W0750/VM5	
WVM 1230 - 1450	RKSCD-F250/16/VA	2	Flow-distributor at vessel outlet			
WVM 45 - 80	GASKIT50W	1	Flat-gasket DN40			
WVM 125 - 210	GASKIT80W	1	Flat-gasket DN50			
WVM 310 - 370	GASKIT100W	1	Flat-gasket DN80			
WVM 520 - 750	GASKIT150W	1	Flat-gasket DN100			
WVM 800 - 1080	GASKIT200W	1	Flat-gasket DN150			
WVM 1230 - 1450	GASKIT250W	1	Flat-gasket DN200			

Replacement filter elements for pre- and after filters

for Dryer model	Dryer Inlet	Dryer Outlet		Filtration Performance	High efficien. filter	Oil Vapour Reduc. Filter	Gen. Purp.Dry Particulate filter
	High effiec. Element	Oil Vapour Reduc. Filter	Gen. Purp. Dry Partic. element				
WVM 45	P035AA	AK_W on request	P035AO	Filtration Grade	Grade AA	≤0.003 mg/m3 ≤0.003 ppm (w)	Grade AO
WVM 60	P040AA		P040AO	Filtration Type	Coalescing		Dry Particulate
WVM 80	P045AA		P045AO	Particle Reduction (inc water & oil aerosol)	Down to 0.01 micron		Down to 1 micron
WVM 125 - 210	P065AA		P065AO	Max. Remain. Oil Aerosol content at 21 °C	≤0.01 mg/m³		N/A
WVM 310 - 370	P070AA		P070AO				
WVM 520 - 615	P075AA		P075AO				
WVM 750	P080AA		P080AO	Max- Remain. Oil Vapour content at system temp.	N/A		N/A
WVM 800 - 1080	-		-				
WVM 1230 - 1450	-		-	Filtration Efficiency	99.9999%		99.925%



WVM Concept Series

GENERATION 4

from 5/2012 to the present day

For the maintenance of this product range, 12/36, 24 and 48 month service-kits are required, together with other components referenced below. Furthermore a 48 month maintenance interval requires a DESMIX-package (Adsorption material package) containing all filling-materials, seals and flow-distributor for the dryer model in question. It makes good sense to combine this 48 month inspection period with the periodic inspection requirements of the authorities for pressure vessel safety, where this is market relevant.

12 and 36 month interval

Material required: Service-kit, Pre- and after filter elements, Silencers
 Service-kit contents: Filter elements for control-air, Pilot valves.
 Options: Dew-point sensor ZHM100/450.

WVM	Material required – PMC Order No.			Options – PMC Order No.	
Product code	Service-kit	Filter-element	Silencer	Others	
WVM40-1450	SKW40-W1450/VM4/12	See replacement filter elements on opposite page	See table – 48 months	ZHM100/450	

24 month interval

Material required: Service-kit, Pre-and after filter elements, Silencers
 Service-kit contents: Filter elements for control-air, Pilot valves, Worn-parts-kit for the expansion valve (V5) and re-pressurisation valve (V4)
 Options: Dew-point sensor ZHM100/450

WVM	Material required – PMC Order No.			Options – PMC Order No.	
Product code	Service-kit	Filter-element	Silencer	Others	
WVM 40-355	SKW40-W355/VM4/24	See replacement filter elements on opposite page	See table – 48 months	ZHM100/450	
WVM 410-710	SKW410-W710/VM4/24				
WVM 800-1080	SKW800-W1080/VM4/24				
WVM 1230-1450	SKW1230-W1450/VM4/24				

48 month interval

Material required: Service-kit, Pre-and after filter elements, DESMIX- package (see oposite), Silencers
 Service-kit contents: Filter elements for control-air, Solenoid valves, Worn-parts-kit for the expansion valve (V5) and re-pressurisation valve (V4), Worn-parts-kit for isolation valve (V3), Non-return valve (RV)
 Options: Dew-point sensor ZHM100/450

WVM	Material required – PMC Order No.						Options	
Product code	Service-kit					Filter-element	Silencer	Others
	Old	until	Actual	from	S.N.			
WVM 40 - 50	SKW40-W50/VM4/48	22/07/18	SKW40-W50/VM4-E/48	23/07/18	39954278	See replacement filter elements on opposite page	1 X SDD-25/AL	ZHM 100/450
WVM 65 - 85	SKW65-W85/VM4/48	14/06/18	SKW65-W85/VM4-E/48	15/06/18	39951814		1 X SDD-25/AL	
WVM 120 – 200	SKW120-W200/VM4/48	22/03/18	SKW120-W200/VM4-E/48	23/03/18	39944769		1 X SDD-25/AL	
WVM 235 - 355	SKW235-W355/VM4/48	14/03/18	SKW235-W355/VM4-E/48	15/03/18	39944122		1 X SDD-25/AL	
WVM 410 – 710	SKW410-W710/VM4/48	08/05/18	SKW410-W710/VM4-E/48	09/05/18	39948240		2 X SDD-25/AL	
WVM 800 - 1080			SKW800-W1080/VM4/48				2 X SDD-25/AL	
WVM 1230-1450			SKW1230-W1450/VM4/48				6 X SDD-40/AL	

WVM Concept Series

GENERATION 4
from 5/2012 to the present day



Contents of the DESMIX-package: All filling-materials, Seals and flow-distributor

WVM	PMC Order-No.	WVM	PMC Order-No.	WVM	PMC Order-No.	WVM	PMC Order-No.
Product Code	DESMIX-package	Product Code	DESMIX-package	Product Code	DESMIX-package	Product Code	DESMIX-package
WVM 40	WVM40DESMIX	WVM 150	WVM150DESMIX	WVM 410	WVM410DESMIX	WVM 800	WVM800DESMIX
WVM 50	WVM50DESMIX	WVM 200	WVM200DESMIX	WVM 475	WVM475DESMIX	WVM 920	WVM920DESMIX
WVM 65	WVM65DESMIX	WVM 235	WVM235DESMIX	WVM 525	WVM525DESMIX	WVM 1080	WVM1080DESMIX
WVM 85	WVM85DESMIX	WVM 300	WVM300DESMIX	WVM 620	WVM620DESMIX	WVM 1230	WVM1230DESMIX
WVM 120	WVM120DESMIX	WVM 355	WVM355DESMIX	WVM 710	WVM710DESMIX	WVM 1450	WVM1450DESMIX

Additional Spare-parts (Individual parts)

for Dryer model	PMC Order-No.	Quantity	Scope of supply
WVM 40 - 50	RKSCD-F40/16/VA	2	Flow-distributor at vessel outlet
WVM 65 - 85	RKSCD-F50/16/VA	2	Flow-distributor at vessel outlet
WVM 120 - 200	RKSCD-F80/16/VA	2	Flow-distributor at vessel outlet
WVM 235 - 355	RKSCD-F100/16/VA	2	Flow-distributor at vessel outlet
WVM 410 - 710	RKSCD-F150/16/VA	2	Flow-distributor at vessel outlet
WVM 800 - 1080	RKSCD-F200/10/VA	2	Flow-distributor at vessel outlet
WVM 1230 - 1450	RKSCD-F250/10/VA	2	Flow-distributor at vessel outlet
WVM 40 - 50	GASKIT40W	1	Flat-gasket DN40
WVM 65 - 85	GASKIT50W	1	Flat-gasket DN50
WVM 120 - 200	GASKIT80W	1	Flat-gasket DN80
WVM 235 - 355	GASKIT100W	1	Flat-gasket DN100
WVM 410 - 710	GASKIT150W	1	Flat-gasket DN150
WVM 800 - 1080	GASKIT200W	1	Flat-gasket DN200
WVM 1230 - 1450	GASKIT250W	1	Flat-gasket DN250

Replacement filter elements for pre- and after filters

Filter housing code	Filter-element PMC Order-No	Filter housing code	Filter-element PMC Order-No	Quantity	Filter housing code	Filter-element PMC Order-No	Quantity
Element grade VL, ZL, XL, A		Element grade V, ZP, XP, A			Element grade V, ZP, XP, A		
GL12_	CP4040_	F14_	3050_	1	F40_	3075_	4
GL13_	CP4050_	F17_	3075_	1	F60_	3075_	6
GL14_	CP4065_	F19_	5075_	1	F80_	3075_	8
GL17_	CP5065_	F20_	3075_	2	F100_	3075_	10
GL19_	CP5080_	F30_	3075_	3	F120_	3075_	12

The code spacing_ should contain the filter-element grade required.

Example: Filter GL14XL containing filter element CP4065XL or filter F19XP containing with filter element 5075XP.



WVM Concept Series

GENERATION 3

from 4/2009 to 4/2012

For the maintenance of this product range, 12/36, 24 and 48 month service-kits are required, together with other components referenced below. Furthermore a 48 month maintenance interval requires a DESMIX-package (Adsorption material package) containing all filling-materials, seals and flow-distributor for the dryer model in question. It makes good sense to combine this 48 month inspection period with the periodic inspection requirements of the authorities for pressure vessel safety, where this is market relevant.

12 and 36 month interval

Material required: Service-kit, Pre- and after filter elements, Silencers
 Service-kit contents: Filter elements for control-air, Pilot valves.
 Options: Dew-point sensor ZHM100/450.

WVM	Material required – PMC Order No.			Options – PMC Order No.	
Product code	Service-kit	Filter-element	Silencer	Others	
WVM 40 - 1450	WVM312A	See replacement filter elements on opposite page	See table – 48 months	ZHM100/450	

24 month interval

Material required: Service-kit, Pre-and after filter elements, Silencers
 Service-kit contents: Filter elements for control-air, Pilot valves, Worn-parts-kit for the expansion valve (V5) and re-pressurisation valve (V4)
 Options: Dew-point sensor ZHM100/450

WVM	Material required – PMC Order No.			Options – PMC Order No.	
Product code	Service-kit	Filter-element	Silencer	Others	
WVM 40 - 355	WVM324A	See replacement filter elements on opposite page	See table – 48 months	ZHM100/450	
WVM 410 - 710	WVM324B				
WVM 800 - 1080	WVM324C				
WVM 1230 - 1450	WVM324D				

48 month interval

Material required: Service-kit, Pre-and after filter elements, DESMIX- package (see oposite), Silencers
 Service-kit contents: Filter elements for control-air, Solenoid valves, Worn-parts-kit for the expansion valve (V5) and re-pressurisation valve (V4), Worn-parts-kit for isolation valve (V3), Non-return valve (RV)
 Options: Dew-point sensor ZHM100/450

WVM	Material required – PMC Order No.			Options – PMC Order No.	
Product code	Service-kit	Filter-element	Silencer	Others	
WVM 40 - 50	WVM348A	See replacement filter elements on opposite page	1 X SDD-25/AL	ZHM100/450	
WVM 65 - 85	WVM348B		1 X SDD-25/AL		
WVM 120 – 200	WVM348C		1 X SDD-25/AL		
WVM 235 - 355	WVM348D		1 X SDD-25/AL		
WVM 410 – 710	WVM348E		2 X SDD-25/AL		
WVM 800 - 1080	WVM348F		2 X SDD-25/AL		
WVM 1230 - 1450	WVM348G		6 X SDD-40/AL		

WVM Concept Series

GENERATION 3
from 4/2009 to 4/2012



Contents of the DESMIX-package: All filling-materials, Seals and flow-distributor

WVM	PMC Order-No.	WVM	PMC Order-No.	WVM	PMC Order-No.	WVM	PMC Order-No.
Product Code	DESMIX-package	Product Code	DESMIX-package	Product Code	DESMIX-package	Product Code	DESMIX-package
WVM 40	WVM40DESMIX	WVM 150	WVM150DESMIX	WVM 410	WVM410DESMIX	WVM 800	WVM800DESMIX
WVM 50	WVM50DESMIX	WVM 200	WVM200DESMIX	WVM 475	WVM475DESMIX	WVM 920	WVM920DESMIX
WVM 65	WVM65DESMIX	WVM 235	WVM235DESMIX	WVM 525	WVM525DESMIX	WVM 1080	WVM1080DESMIX
WVM 85	WVM85DESMIX	WVM 300	WVM300DESMIX	WVM 620	WVM620DESMIX	WVM 1230	WVM1230DESMIX
WVM 120	WVM120DESMIX	WVM 355	WVM355DESMIX	WVM 710	WVM710DESMIX	WVM 1450	WVM1450DESMIX

Additional Spare-parts (Individual parts)

for Dryer model	PMC Order-No.	Quantity	Scope of supply
WVM 40 - 50	RKSCD-F40/16/VA	2	Flow-distributor at vessel outlet
WVM 65 - 85	RKSCD-F50/16/VA	2	Flow-distributor at vessel outlet
WVM 120 - 200	RKSCD-F80/16/VA	2	Flow-distributor at vessel outlet
WVM 235 - 355	RKSCD-F100/16/VA	2	Flow-distributor at vessel outlet
WVM 410 - 710	RKSCD-F150/16/VA	2	Flow-distributor at vessel outlet
WVM 800 - 1080	RKSCD-F200/10/VA	2	Flow-distributor at vessel outlet
WVM 1230 - 1450	RKSCD-F250/10/VA	2	Flow-distributor at vessel outlet
WVM 40 - 50	GASKIT40W	1	Flat-gasket DN40
WVM 65 - 85	GASKIT50W	1	Flat-gasket DN50
WVM 120 - 200	GASKIT80W	1	Flat-gasket DN80
WVM 235 - 355	GASKIT100W	1	Flat-gasket DN100
WVM 410 - 710	GASKIT150W	1	Flat-gasket DN150
WVM 800 - 1080	GASKIT200W	1	Flat-gasket DN200
WVM 1230 - 1450	GASKIT250W	1	Flat-gasket DN250

Replacement filter elements for pre- and after filters

Filter housing code	Filter-element PMC Order-No	Filter housing code	Filter-element PMC Order-No	Quantity	Filter housing code	Filter-element PMC Order-No	Quantity
Element grade VL, ZL, XL, A		Element grade V, ZP, XP, A			Element grade V, ZP, XP, A		
G12_	2030_	F14_	3050_	1	F40_	3075_	4
G13_	2050_	F17_	3075_	1	F60_	3075_	6
G14_	3050_	F19_	5075_	1	F80_	3075_	8
G17_	3075_	F20_	3075_	2	F100_	3075_	10
G18_	5060_	F30_	3075_	3	F120_	3075_	12
G19_	5075_						

The code spacing_ should contain the filter-element grade required.

Example: Filter GL14XL containing filter element CP4065XL or filter F19XP containing with filter element 5075XP.



WVM Concept Series

GENERATION 2

from 2007 to 4/2009

For the maintenance of this product range, 12/36, 24 and 48 month service-kits are required, together with other components referenced below. Furthermore a 48 month maintenance interval requires a DESMIX-package (Adsorption material package) containing all filling-materials, seals and flow-distributor for the dryer model in question. It makes good sense to combine this 48 month inspection period with the periodic inspection requirements of the authorities for pressure vessel safety, where this is market relevant.

12 and 36 month interval

Material required: Service-kit, Pre- and after filter elements, Silencers
 Service-kit contents: Filter elements for control-air, Pilot valves.
 Options: Dew-point sensor ZHM100/450.

WVM	Material required – PMC Order No.			Options – PMC Order No.	
Product code	Service-kit	Filter-element	Silencer	Others	
WVM 40 - 1450	WVM212A	See replacement filter elements on opposite page	See table – 48 months	ZHM100/450	

24 month interval

Material required: Service-kit, Pre-and after filter elements, Silencers
 Service-kit contents: Filter elements for control-air, Pilot valves, Worn-parts-kit for the expansion valve (V5) and re-pressurisation valve (V4)
 Options: Dew-point sensor ZHM100/450

WVM	Material required – PMC Order No.			Options – PMC Order No.	
Product code	Service-kit	Filter-element	Silencer	Others	
WVM 40 - 355	WVM224A	See replacement filter elements on opposite page	See table – 48 months	ZHM100/450	
WVM 410 - 710	WVM224B				
WVM 800 - 1080	WVM224C				
WVM 1230 - 1450	WVM224D				

48 month interval

Material required: Service-kit, Pre-and after filter elements, DESMIX- package (see oposite), Silencers
 Service-kit contents: Filter elements for control-air, Solenoid valves, Worn-parts-kit for the expansion valve (V5) and re-pressurisation valve (V4), Worn-parts-kit for isolation valve (V3), Non-return valve (RV)
 Options: Dew-point sensor ZHM100/450

WVM	Material required – PMC Order No.			Options – PMC Order No.	
Product code	Service-kit	Filter-element	Silencer	Others	
WVM 40 - 50	WVM248A	See replacement filter elements on opposite page	1 X SDD-25/AL	ZHM100/450	
WVM 65 - 85	WVM248B		1 X SDD-25/AL		
WVM 120 – 200	WVM248C		1 X SDD-25/AL		
WVM 235 - 355	WVM248D		1 X SDD-25/AL		
WVM 410 – 710	WVM248E		2 X SDD-25/AL		
WVM 800 - 1080	WVM248F		2 X SDD-25/AL		
WVM 1230-1450	WVM248G		6 X SDD-40/AL		

WVM Concept Series

GENERATION 2
from 2007 to 4/2009



Contents of the DESMIX-package: All filling-materials, Seals and flow-distributor

WVM	PMC Order-No.	WVM	PMC Order-No.	WVM	PMC Order-No.	WVM	PMC Order-No.
Product Code	DESMIX-package	Product Code	DESMIX-package	Product Code	DESMIX-package	Product Code	DESMIX-package
WVM 40	WVM40DESMIX	WVM 150	WVM150DESMIX	WVM 410	WVM410DESMIX	WVM 800	WVM800DESMIX
WVM 50	WVM50DESMIX	WVM 200	WVM200DESMIX	WVM 475	WVM475DESMIX	WVM 920	WVM920DESMIX
WVM 65	WVM65DESMIX	WVM 235	WVM235DESMIX	WVM 525	WVM525DESMIX	WVM 1080	WVM1080DESMIX
WVM 85	WVM85DESMIX	WVM 300	WVM300DESMIX	WVM 620	WVM620DESMIX	WVM 1230	WVM1230DESMIX
WVM 120	WVM120DESMIX	WVM 355	WVM355DESMIX	WVM 710	WVM710DESMIX	WVM 1450	WVM1450DESMIX

Generation Update

These parts have been chosen in such a way that component updating to the current specification is possible. As deviations can occur, please contact your Parker sales office prior to carrying out this work. Please ensure when contacting Parker that you are in possession of the construction number of the dryer in question or of the control cabinet.

WVM	Material required – PMC Order No.			Optional PMC Order-No.	
Product Code	Controls	Valve-technology			
WVM 40 - 200	UK-ZDMC-W40-200				
WVM 235 - 475	UK-ZDMC-W235-475				
WVM 525 - 800	UK-ZDMC-W525-800				

Additional Spare-parts (Individual parts), see Generation 3 or 4.

Replacement filter elements for pre- and after filters

Filter housing code	Filter-element PMC Order-No	Filter housing code	Filter-element PMC Order-No	Quantity	Filter housing code	Filter-element PMC Order-No	Quantity
Element grade VL, ZL, XL, A		Element grade V, ZP, XP, A			Element grade V, ZP, XP, A		
G12_	2030_	F14_	3050_	1	F40_	3075_	4
G13_	2050_	F17_	3075_	1	F60_	3075_	6
G14_	3050_	F19_	5075_	1	F80_	3075_	8
G17_	3075_	F20_	3075_	2	F100_	3075_	10
G18_	5060_	F30_	3075_	3	F120_	3075_	12
G19_	5075_						

The code spacing_ should contain the filter-element grade required.

Example: Filter GL14XL containing filter element CP4065XL or filter F19XP containing with filter element 5075XP.



WVM Concept Series

GENERATION 1

from 2000 to 2006

For the maintenance of this product range, 12/36, 24 and 48 month service-kits are required, together with other components referenced below. Furthermore a 48 month maintenance interval requires a DESMIX-package (Adsorption material package) containing all filling-materials, seals and flow-distributor for the dryer model in question. It makes good sense to combine this 48 month inspection period with the periodic inspection requirements of the authorities for pressure vessel safety, where this is market relevant.

12 and 36 month interval

Material required: Service-kit, Pre- and after filter elements, Silencers
 Service-kit contents: Filter elements for control-air, Pilot valves.
 Options: Dew-point sensor ZHM100/450.

WVM	Material required – PMC Order No.			Options – PMC Order No.	
Product code	Service-kit	Filter-element	Silencer	Others	
WVM 40 - 1450	WVM12A	See replacement filter elements on opposite page	See table – 48 months	ZHM100/450	

24 month interval

Material required: Service-kit, Pre-and after filter elements, Silencers
 Service-kit contents: Filter elements for control-air, Pilot valves, Worn-parts-kit for the expansion valve (V5) and re-pressurisation valve (V4)
 Options: Dew-point sensor ZHM100/450

WVM	Material required – PMC Order No.			Options – PMC Order No.	
Product code	Service-kit	Filter-element	Silencer	Others	
WVM 40 - 355	WVM24A	See replacement filter elements on opposite page	See table – 48 months	ZHM100/450	
WVM 410 - 710	WVM24B				
WVM 800 - 1080	WVM24C				
WVM 1230 - 1450	WVM24D				

48 month interval

Material required: Service-kit, Pre-and after filter elements, DESMIX- package (see oposite), Silencers
 Service-kit contents: Filter elements for control-air, Solenoid valves, Worn-parts-kit for the expansion valve (V5) and re-pressurisation valve (V4), Worn-parts-kit for isolation valve (V3), Non-return valve (RV)
 Options: Dew-point sensor ZHM100/450

WVM	Material required – PMC Order No.			Options – PMC Order No.	
Product code	Service-kit	Filter-element	Silencer	Others	
WVM 40 - 50	WVM48A	See replacement filter elements on opposite page	1 X SDD-25/AL	ZHM100/450	
WVM 65 - 85	WVM48B		1 X SDD-25/AL		
WVM 120 – 200	WVM48C		1 X SDD-25/AL		
WVM 235 - 355	WVM48D		1 X SDD-25/AL		
WVM 410 – 710	WVM48E		2 X SDD-25/AL		
WVM 800 - 1080	WVM48F		2 X SDD-25/AL		
WVM 1230-1450	WVM48G		6 X SDD-40/AL		

WVM Concept Series

GENERATION 1
from 2000 to 2006



Contents of the DESMIX-package: All filling-materials, Seals and flow-distributor

WVM	PMC Order-No.	WVM	PMC Order-No.	WVM	PMC Order-No.	WVM	PMC Order-No.
Product Code	DESMIX-package	Product Code	DESMIX-package	Product Code	DESMIX-package	Product Code	DESMIX-package
WVM 40	WVM40DESMIX	WVM 150	WVM150DESMIX	WVM 410	WVM410DESMIX	WVM 800	WVM800DESMIX
WVM 50	WVM50DESMIX	WVM 200	WVM200DESMIX	WVM 475	WVM475DESMIX	WVM 920	WVM920DESMIX
WVM 65	WVM65DESMIX	WVM 235	WVM235DESMIX	WVM 525	WVM525DESMIX	WVM 1080	WVM1080DESMIX
WVM 85	WVM85DESMIX	WVM 300	WVM300DESMIX	WVM 620	WVM620DESMIX	WVM 1230	WVM1230DESMIX
WVM 120	WVM120DESMIX	WVM 355	WVM355DESMIX	WVM 710	WVM710DESMIX	WVM 1450	WVM1450DESMIX

Additional Spare-parts (Individual parts)

for Dryer model	PMC Order-No.	Quantity	Scope of supply
WVM 40 - 50	RKSCD-F40/16/VA	2	Flow-distributor at vessel outlet
WVM 65 - 85	RKSCD-F50/16/VA	2	Flow-distributor at vessel outlet
WVM 120 - 200	RKSCD-F80/16/VA	2	Flow-distributor at vessel outlet
WVM 235 - 355	RKSCD-F100/16/VA	2	Flow-distributor at vessel outlet
WVM 410 - 710	RKSCD-F150/16/VA	2	Flow-distributor at vessel outlet
WVM 800 - 1080	RKSCD-F200/10/VA	2	Flow-distributor at vessel outlet
WVM 1230 - 1450	RKSCD-F250/10/VA	2	Flow-distributor at vessel outlet
WVM 40 - 50	GASKIT40W	1	Flat-gasket DN40
WVM 65 - 85	GASKIT50W	1	Flat-gasket DN50
WVM 120 - 200	GASKIT80W	1	Flat-gasket DN80
WVM 235 - 355	GASKIT100W	1	Flat-gasket DN100
WVM 410 - 710	GASKIT150W	1	Flat-gasket DN150
WVM 800 - 1080	GASKIT200W	1	Flat-gasket DN200
WVM 1230 - 1450	GASKIT250W	1	Flat-gasket DN250

Replacement filter elements for pre- and after filters

Filter housing code	Filter-element PMC Order-No	Filter housing code	Filter-element PMC Order-No	Quantity	Filter housing code	Filter-element PMC Order-No	Quantity
Element grade VL, ZL, XL, A		Element grade V, ZP, XP, A			Element grade V, ZP, XP, A		
G12_	2030_	F14_	3050_	1	F40_	3075_	4
G13_	2050_	F17_	3075_	1	F60_	3075_	6
G14_	3050_	F19_	5075_	1	F80_	3075_	8
G17_	3075_	F20_	3075_	2	F100_	3075_	10
G18_	5060_	F30_	3075_	3	F120_	3075_	12
G19_	5075_						

The code spacing_ should contain the filter-element grade required.

Example: Filter GL14XL containing filter element CP4065XL or filter F19XP containing with filter element 5075XP.

Heatless Adsorption Dryers

K-MT 1-8, K-MT 1-8,
KM 5-115 Series





K-MT 1-8 Series

GENERATION 3 (OIL-X filter)

From 01/2019 to the present day

For the maintenance of this product range, 12/36, 24 and 48 month service-kits are required, together with other components referenced below. Furthermore a 48 month maintenance interval requires an exchange of desiccant (see DESPACs).

12 and 36 month interval

Material required: Service-kit
 Service-kit contents: Re-set module, silencer, filter elements
 Options: Dew-point sensor ZHM100/450.

K-MT	Material required - PMC Order-No.			Options - PMC Order-No.	
Product Code	Service-kit	Mains voltage		Others	
K-MT 1-4	SKK1-K4/D3/12	115V, 230V		ZHM100/450	
K-MT 6-7	SKK6-K7/D3/12				
K-MT 8	SKK8/D3/12				

24 month interval

Material required: Service-kit
 Service-kit contents: Re-set module, silencer, filter elements, wear part set for in-/outlet-valves
 Options: Dew point sensor ZHM100/450

K-MT	Material required - PMC Order-No.			Options - PMC Order-No.	
Product Code	Service-kit	Mains voltage		Others	
K-MT 1-4	SKK1-K4/D3/24	115V, 230V		ZHM100/450	
K-MT 6-7	SKK6-K7/D3/24				
K-MT 8	SKK8/D3/24				

48 month interval

Material required: Service-kit, DESPACs see on opposite page
 Service-kit contents: Re-set module, silencer, filter elements, perforated plates, perforated plate gaskets, solenoid coils 230V, wear part set for in-/outlet-valves, non-return valves, 2 demister pads,
 Options: Dew point sensor ZHM100/450

K-MT	Material required - PMC Order-No.			Options - PMC Order-No.	
Product Code	Service-kit	Mains voltage		Others	
K-MT 1-4	SKK1-K4/D3/48	230V		ZHM/100/450	
	SKK1-K4/D3/48/115	115V			
K-MT 6-7	SKK6-K7/D3/48	230V			
	SKK6-K7/D3/48/115	115V			
K-MT 8	SKK8/D3/48	230V			
	SKK8/D3/48/115	115V			

Options : coils only for 50Hz (398H254061)

K-MT 1-8 Series

GENERATION 3 (OIL-X filter)
From 01/2019 to the present day



DESPACs

48 month interval

Content DESPACs: Molecular sieve in 1 kg, 4 kg or 15 kg packs

PMC Order-No.	K-MT 1	K-MT 2	K-MT 3	K-MT 4	K-MT 6	K-MT 7	K-MT 8
DESPAC1MS	1		1			2	1
DESPAC4MS		1	1	2			1
DESPAC15MS					1	1	1

Replacement filter elements for pre- and after filters (filter elements are included in the service-kit)

K-MT	PMC Order-No.			
Product code	Upstream filter	Element grade	Downstream filter	Element grade
K-MT 1	AAP010AGFI	P010AA	AOP010AGMI	P010AO
K-MT 2	AAP010AGFI	P010AA	AOP010AGMI	P010AO
K-MT 3	AAP010AGFI	P010AA	AOP010AGMI	P010AO
K-MT 4	AAP010AGFI	P010AA	AOP010AGMI	P010AO
K-MT 6	AAP015AGFI	P015AA	AOP015AGMI	P015AO
K-MT 7	AAP015AGFI	P015AA	AOP015AGMI	P015AO
K-MT 8	AAP020AGFI	P020AA	AOP020AGMI	P020AO

The code spacing_ should contain the filter-element grade required. Example: Filter AAP010AGFI containing filter-element P010AA.

Loose accessories

Suitable for	PMC Order-No.	Use	Suitable for	PMC Order-No.	Use
K-MT 1 - 8	VASRGR/K1-K8	Balance-line	K-MT 1 - 4	VASVPB/K1-K4/08	Starting device G1/4i
K-MT 1 - 95	VASDPD/K1-K95	Dew point measurement	K-MT 6 - 7	VASVPB/K6-K7/15	Starting device G1/2i
K-MT 1 - 95	VASMBS420	Signal Splitter 4-20 mA	K-MT 8	VASVPB/K8/20	Starting device G3/4i
K-MT 1 - 95	VASNOZ/K1-K95	Nozzle-kit	K-MT 1 - 4	VASF3/K1-K4	Fine filter silencer
K-MT 1 - 8	VASSDD08/15	Silencer	K-MT 6 - 8	VASF5/K6-K8	Fine filter silencer



K-MT 1-8 Series

GENERATION 2

From 07/2011 to 12/2018

For the maintenance of this product range, 12/36, 24 and 48 month service-kits are required, together with other components referenced below. Furthermore a 48 month maintenance interval requires an exchange of desiccant (see DESPACs).

12 and 36 month interval

Material required: Service-kit
 Service-kit contents: Re-set module, silencer, filter elements
 Options: Dew-point sensor ZHM100/450.

K-MT	Material required - PMC Order-No.			Options - PMC Order-No.	
Product Code	Service-kit			Others	
K-MT 1-4	SKK1-K4/D2/12			ZHM100/450	
K-MT 6-7	SKK6-K7/D2/12				
K-MT 8	SKK8/D2/12				

24 month interval

Material required: Service-kit
 Service-kit contents: Re-set module, silencer, filter elements, wear part set for in-/outlet-valves
 Options: Dew point sensor ZHM100/450

K-MT	Material required - PMC Order-No.			Options - PMC Order-No.	
Product Code	Service-kit			Others	
K-MT 1-4	SKK1-K4/D2/24			ZHM100/450	
K-MT 6-7	SKK6-K7/D2/24				
K-MT 8	SKK8/D2/24				

48 month interval

Material required: Service-kit, DESPACs see on opposite page
 Service-kit contents: Re-set module, silencer, filter elements, perforated plates, perforated plate gaskets, solenoid coils 230V, wear part set for in-/outlet-valves, non-return valves, 2 demister pads,
 Options: Dew point sensor ZHM100/450

K-MT	Material required - PMC Order-No.			Options - PMC Order-No.	
Product Code	Service-kit			Others	
K-MT 1-4	SKK1-K4/D2/48			ZHM/100/450	
K-MT 6-7	SKK6-K7/D2/48				
K-MT 8	SKK8/D2/48				

K-MT 1-8 Series

GENERATION 2

From 07/2011 to 12/2018



DESPACs

48 month interval

Content DESPACs: Molecular sieve in 1 kg, 4 kg or 15 kg packs

PMC Order-No.	K-MT 1	K-MT 2	K-MT 3	K-MT 4	K-MT 6	K-MT 7	K-MT 8
DESPAC1MS	1		1		1		
DESPAC4MS		1	1	2	3	4	1
DESPAC15MS							1

Replacement filter elements for pre- and after filters (filter elements are included in the service-kit)

K-MT	PMC Order-No.		K-MT	PMC Order-No.	
Product code	Filter housing size	Element grade VL, ZL, XL, A	Product code	Filter housing size	Element grade VL, ZL, XL, A
K-MT 1	GL2	CP1008_	K-MT 6	GL5	CP2010_
K-MT 2	GL2	CP1008_	K-MT 7	GL5	CP2010_
K-MT 3	GL2	CP1008_	K-MT 8	GL7	CP2020_
K-MT 4	GL2	CP1008_			

The code spacing_ should contain the filter-element grade required. Example: Filter GL2XL containing filter-element CP1008XL.

Loose accessories

Suitable for	PMC Order-No.	Use	Suitable for	PMC Order-No.	Use
K-MT 1 - 8	VASRGR/K1-K8	Balance-line	K-MT 1 - 4	VASVPB/K1-K4/08	Starting device G1/4i
K-MT 1 - 95	VASPDP/K1-K95	Dew point measurement	K-MT 6 - 7	VASVPB/K6-K7/15	Starting device G1/2i
K-MT 1 - 95	VASMBS420	Signal Splitter 4-20 mA	K-MT 8	VASVPB/K8/20	Starting device G3/4i
K-MT 1 - 95	VASNOZ/K1-K95	Nozzle-kit	K-MT 1 - 4	VASFS3/K1-K4	Fine filter silencer
K-MT 1 - 8	VASSDD08/15	Silencer	K-MT 6 - 8	VASFS5/K6-K8	Fine filter silencer

K-MT 1-8 Series



GENERATION 1

From 05/2003 to 06/2011

For the maintenance of this product range, 12/36, 24 and 48 month service-kits are required, together with other components referenced below. Furthermore a 48 month maintenance interval requires an exchange of desiccant (see DESPACs).

12 and 36 month interval

Material required: Service-kit, filter elements, silencer
 Service-kit contents: Re-set module
 Options: Dew point sensor ZHM 100/450

K-MT	Material required - PMC Order-No.			Options - PMC Order-No.	
Product Code	Service-kit	Filter-element	Silencer	Others	
K-MT 1 - 8	K-MT12A	See replacement filter elements on opposite page	VASSDD08/15	ZHM100/450	

24 month interval

Material required: Service-kit, filter elements, silencer,
 Service-kit contents: Re-set module, wear part set for in-/outlet-valves
 Options: Dew point sensor ZHM100/450

K-MT	Material required - PMC Order-No.			Options - PMC Order-No.	
Product Code	Service-kit	Filter-element	Silencer	Others	
K-MT 1 - 8	K-MT24A	See replacement filter elements on opposite page	VASSDD08/15	ZHM100/450	

48 month interval

Material required: Service-kit, silencer, filter elements, DESPACs see on opposite page
 Service-kit contents: Re-set module, perforated plates, perforated plate gaskets, solenoid coils 230V, wear part set for in-/outlet-valves, non-return valves, 2 Demisters
 Options: Dew point sensor ZHM100/450

K-MT	Material required -PMC Order-No.			Options - PMC Order-No.	
Product Code	Service-kit	Filter-element	Silencer	Others	
K-MT 1 - 4	K-MT48A	See replacement filter elements on opposite page	VASSDD08/15	ZHM100/450	
K-MT 6 - 8	K-MT48B				

K-MT 1-8 Series

GENERATION 1

From 05/2003 to 06/2011



DESPACs

48 month interval

Content DESPACs: Molecular sieve in 1 kg, 4 kg or 15 kg packs

PMC Order-No.	K-MT 1	K-MT 2	K-MT 3	K-MT 4	K-MT 6	K-MT 7	K-MT 8
DESPAC1MS	1		1		1		
DESPAC4MS		1	1	2	3	4	1
DESPAC15MS							1

Replacement filter elements for pre- and after filters

K-MT	PMC Order-No.		K-MT	PMC Order-No.	
Product code	Filter housing size	Element grade V, ZP, XP, A	Product code	Filter housing size	Element grade V, ZP, XP, A
K-MT 1	G2	1030_	K-MT 6	G5	1070_
K-MT 2	G2	1030_	K-MT 7	G5	1070_
K-MT 3	G2	1030_	K-MT 8	G7	1140_
K-MT 4	G2	1030_			

The code spacing_ should contain the filter-element grade required. Example: Filter G2XP containing filter element 1030XP.

Loose accessories

Suitable for	PMC Order-No.	Use	Suitable for	PMC Order-No.	Use
K-MT 1 - 8	VASRGR/K1-K8	Balance-line	K-MT 1 - 4	VASVPB/K1-K4/08	Starting device G1/4i
K-MT 1 - 95	VASDPD/K1-K95	Dew point measurement	K-MT 6 - 7	VASVPB/K6-K7/10	Starting device G3/8i
K-MT 1 - 95	VASMBS420	Signal Splitter 4-20 mA	K-MT 8	VASVPB/K6-K7/15	Starting device G1/2i
K-MT 1 - 95	VASNOZ/K1-K95	Nozzle-kit	K-MT 1 - 4	VASFS3/K1-K4	Fine filter silencer
K-MT 1 - 8	VASSDD08/15	Silencer	K-MT 6 - 8	VASFS5/K6-K8	Fine filter silencer

KM 5-115 Series



GENERATION 0

Up to mid. 2003

Generation 0 dryers should be updated once to the latest technical specification using the following retrofit kits.

For the maintenance of the updated series, 12/36, 24 and 48 month service-kits are required, together with other components referenced below. Furthermore a 48 month maintenance interval requires an exchange of desiccant (see DESPACs).

Update-kit

Suitable for	PMC Order-No.	Replaceable contents
KM 5 - 35	UKKM5-35	Solenoid valve plate incl. seals + cable + socket-coupling
KM 5 - 35	UKKM5-35/RV	Non-return valve plate incl. seals - without nozzle
KM 75 - 115	UKKM75-115	Solenoid valve plate incl. seals + cable + socket-coupling
KM 75 - 115	UKKM75-115/RV	Non-return valve plate incl. seals - without nozzle

Update-kit Multitronic

Suitable for	PMC Order-No.	Replaceable contents
KM 5 - 115	UKMT-230-ZHM	Multitronic + cable + ZHM100 + measuring chamber
KM 5 - 115	UKMT-230	Multitronic + cable

After the conversion of the current control Multitronic every 12 month is the following service kit required

KM 5 - 115	K-MT12A	Reset-modul
------------	---------	-------------

12 and 36 month interval

Material required: Filter elements, silencers

Service-kit contents: -

Options: Dew point sensor* (*Dew point sensor can vary in type. Please provide the construction no. of the dryer when making an enquiry.)

KM	Material required - PMC Order-No.			Options - PMC Order-No.	
	Product Code	Service-kit	Filter-element	Silencer	Others
KM 5 - 115		**	See replacement filter elements on opposite page	VASSDD08/15	Dew point sensor*

24 month interval

KM	Material required - PMC Order-No.			Options -PMC Order-No.	
	Product Code	Service-kit	Filter-element	Silencer	Others
KM 5 - 115		KM24A-UG	See replacement filter elements on opposite page	VASSDD08/15	Dew point sensor*

KM 5-115 Series

GENERATION 0
Up to mid. 2003



48 month interval

Material required: Service-kit, filter elements, silencer, DESPACs see below
 Service-kit contents: Perforated plate gaskets, solenoid coils 230V, wear part set for in-/outlet-valves, non-return valves
 Options: Dew point sensor* (*Dew point sensor can vary in type. Please provide the construction no. of the dryer when making an enquiry.)

KM	Material required - PMC Order-No.			Options	
	Service-kit	Filter-element	Silencer	Others	
Product Code					
KM 5 - 35	KM48A-UG	See replacement filter elements on opposite page	VASSDD08/15	Dew point sensor*	
KM 75 - 115	KM48B-UG				

DESPACs

48 month interval

Content DESPACs: Molecular sieve in 1 kg, 4 kg or 15 kg packs

PMC Order-No.	KM 5	KM10	KM 25	KM 35	KM 75	KM 95	KM 115
DESPAC1MS	1		1			2	
DESPAC4MS		1	1	2			2
DESPAC15MS					1	1	1

Replacement filter elements for pre- and after filters

KM	PMC Order-No.		KM	PMC Order-No.	
	Filter housing size	Element grade V, ZP, XP, A		Filter housing size	Element grade V, ZP, XP, A
Product code			Product code		
KM 5	G2	1030_	KM 75	G5	1070_
KM 10	G2	1030_	KM 95	G5	1070_
KM 25	G2	1030_	KM 115	G7	1140_
KM 35	G2	1030_			

The code spacing_ should contain the filter-element grade required. Example: Filter G2XP containing filter element 1030XP.

Heatless Adsorption Dryers

K-MT 10-95, K-MT 10-95,
KE-MT, KEN-MT, KEN Series



K-MT 10-95 Series

GENERATION 3 (OIL-X filter)

From 01/2019 to the present day

For the maintenance of this product range, 12/36, 24 and 48 month service-kits are required, together with other components referenced below. Furthermore a 48 month maintenance interval requires an exchange of desiccant (see DESPACs).

12 and 36 month interval

Material required: Service-kit
 Service-kit contents: Re-set module, silencer, filter elements, pilot valves
 Options: Dew point sensor ZHM100/450

K-MT	Material required - PMC Order-No.			Options - PMC Order-No.	
Model	Service-kit	Mains voltage		Others	
K-MT 10 to 20	SKK10-K20/D3/12	115V, 230V		ZHM100/450	P02/ZR
K-MT 25	SKK25/D3/12	115V, 230V			
K-MT 35	SKK35/D3/12	115V, 230V			
K-MT 45	SKK45/D3/12	115V, 230V			
K-MT 60 - 75	SKK60-K75/D3/12	115V, 230V			
K-MT 95	SKK95/D3/12	115V, 230V			

24 and 48 month interval

Material required: Service-kit,
 48 month interval: Additional DESMIX (see on opposite page)
 Service-kit contents: Re-set module, silencer, filter elements, pilot valves, wear part sets for in-/outlet valves and non-return valves, o-ring sets (in-/external) for solenoid valve block, solenoid coils 230
 Options: Dew point sensor ZHM100/450

K-MT	Material required - PMC Order-No.			Options - PMC Order-No.	
Model	Service-kit	Mains voltage		Others	
K-MT 10 to 20	SKK10-K20/D3/24/115	115V		ZHM100/450	P02/ZR
	SKK10-K20/D3/24	230V			
K-MT 25	SKK25/D3/24/115	115V			
	SKK25/D3/24	230V			
K-MT 35	SKK35/D3/24/115	115V			
	SKK35/D3/24	230V			
K-MT 45	SKK45/D3/24/115	115V			
	SKK45/D3/24	230V			
K-MT 60 - 75	SKK60-K75/D3/24/115	115V			
	SKK60-K75/D3/24	230V			
K-MT 95	SKK95/D3/24/115	115V			
	SKK95/D3/24	230V			

Options : coils only for 50Hz (398H254061)

K-MT 10-95 Series

GENERATION 3(OIL-X filter)

From 01/2019 to the present day

DESMIX

48 month interval

DESMIX content: Molecular sieve in 1 kg, 4 kg, 15 kg or 140 kg packs

Model	PMC Order-No.	Model	PMC Order-No.
K-MT 10	K-MT10DESMIX	K-MT 45	K-MT60DESMIX
K-MT 15	K-MT15DESMIX	K-MT 60	K-MT60DESMIX
K-MT 20	K-MT20DESMIX	K-MT 75	K-MT75DESMIX
K-MT 25	K-MT25DESMIX	K-MT 95	K-MT95DESMIX
K-MT 35	K-MT35DESMIX		

Replacement filter elements for pre- and after filters (filter elements are included in the service-kit)

K-MT	PMC Order-No.			
Model	Upstream filter	Element grade	Downstream filter	Element grade
K-MT 10	AAP025EGFI	P025AA	AOP025EGMI	P025AO
K-MT 15	AAP025EGFI	P025AA	AOP025EGMI	P025AO
K-MT 20	AAP025EGFI	P025AA	AOP025EGMI	P025AO
K-MT 25	AAP030GGFI	P030AA	AOP030GGMI	P030AO
K-MT 35	AAP030GGFI	P030AA	AOP030GGMI	P030AO
K-MT 45	AAP035GGFX	P035AA	AOP035GGMX	P035AO
K-MT 60	AAP040HGFX	P040AA	AOP040HGMX	P040AO
K-MT 75	AAP040HGFX	P040AA	AOP040HGMX	P040AO
K-MT 95	AAP045IGFX	P045AA	AOP045IGMX	P045AO

The underscore_ should be replaced by the element grade required. Example Filter AAP035GGFX containing filter-element P035AA.

Loose accessories

Suitable for	PMC Order No.	Use	Suitable for	PMC Order No.	Use
K-MT 10 - 95	VASDPDP/K1-K95	Dew point measurement	K-MT 10 - 20	VASVPB/K10-K20/25	Start-up device G1i
K-MT 10 - 95	VASMB5420	Signal duplicator 4-20 mA	K-MT 25 - 45	VASVPB/K25-K45/40	Start-up device G1 1/2i
K-MT 10 - 15	VASFS5/K10-K15	Fine filter muffler	K-MT 60 - 75	VASVPB/K60-K75/50	Start-up device G2i
K-MT 20 - 25	VASFS5/K20-K25	Fine filter muffler	K-MT 95	VASVPB/K95/65	Start-up device G2 1/2i
K-MT 35 - 60	VASFS5/K35-K60	Fine filter muffler	K-MT 10 - 95	VASRGR/K10-K95	Regeneration gas return
K-MT 75 - 95	VASFS5/K75-K95	Fine filter muffler	K-MT 10 - 95	VASNOZ/K1-K95	Nozzle kit

K-MT 10-95 Series



GENERATION 2

From 07/2011 to 12/2018

For the maintenance of this product range, 12/36, 24 and 48 month service-kits are required, together with other components referenced below. Furthermore a 48 month maintenance interval requires an exchange of desiccant (see DESPACs).

12 and 36 month interval

Material required: Service-kit
 Service-kit contents: Re-set module, silencer, filter elements, pilot valves
 Options: Dew point sensor ZHM100/450

K-MT	Material required - PMC Order-No.			Options - PMC Order-No.	
Model	Service-kit			Others	
K-MT 10 - 20	SKK10-K20/D2/12			ZHM100/450	
K-MT 25	SKK25/D2/12				
K-MT 35	SKK35/D2/12				
K-MT 45	SKK45/D2/12				
K-MT 60 - 75	SKK60-K75/D2/12				
K-MT 95	SKK95/D2/12				

24 and 48 month interval

Material required: Service-kit,
 48 month intervall: Additional DESMIX (see on opposite page)
 Service-kit contents: Re-set module, silencer, filter elements, pilot valves, wear part sets for in-/outlet valves and non-return valves, o-ring sets (in-/external) for solenoid valve block, solenoid coils 230
 Options: Dew point sensor ZHM100/450

K-MT	Material required - PMC Order-No.			Options - PMC Order-No.	
Model	Service-kit			Others	
K-MT 10 - 20	SKK10-K20/D2/24			ZHM100/450	
K-MT 25	SKK25/D2/24				
K-MT 35	SKK35/D2/24				
K-MT 45	SKK45/D2/24				
K-MT 60 - 75	SKK60-K75/D2/24				
K-MT 95	SKK95/D2/24				

K-MT 10-95 Series

GENERATION 2

From 07/2011 to 12/2018



DESMIX

48 month interval

DESMIX content: Molecular sieve in 1 kg, 4 kg, 15 kg or 140 kg packs

Model	PMC Order-No.	Model	PMC Order-No.
K-MT 10	K-MT10DESMIX	K-MT 35	K-MT35DESMIX
K-MT 15	K-MT15DESMIX	K-MT 45 - 60	K-MT60DESMIX
K-MT 20	K-MT20DESMIX	K-MT 75	K-MT75DESMIX
K-MT 25	K-MT25DESMIX	K-MT 95	K-MT95DESMIX

Replacement filter elements for pre- and after filters (filter elements are included in the service-kit)

K-MT		PMC Order-No.		K-MT		PMC Order-No.	
Model	Filter size	Element grade VL, ZL, XL, A		Model	Filter size	Element grade VL, ZL, XL, A	
K-MT 10	GL9	CP3025_		K-MT 45	GL12	CP4040_	
K-MT 15	GL9	CP3025_		K-MT 60	GL13	CP4050_	
K-MT 20	GL9	CP3025_		K-MT 75	GL13	CP4050_	
K-MT 25	GL11	CP3040_		K-MT 95	GL14	CP4065_	
K-MT 35	GL11	CP3040_					

The underscore_ should be replaced by the element grade required. Example Filter GL9XL containing filter-element CP3025XL.

Loose accessories

Suitable for	PMC Order No.	Use	Suitable for	PMC Order No.	Use
K-MT 10 - 95	VASDPDP/K1-K95	Dew point measurement	K-MT 10 - 20	VASVPB/K10-K20/25	Start-up device G1i
K-MT 10 - 95	VASMBS420	Signal duplicator 4-20 mA	K-MT 25 - 45	VASVPB/K25-K45/40	Start-up device G1 1/2i
K-MT 10 - 15	VASF5/K10-K15	Fine filter muffler	K-MT 60 - 75	VASVPB/K60-K75/50	Start-up device G2i
K-MT 20 - 25	VASF5/K20-K25	Fine filter muffler	K-MT 95	VASVPB/K95/65	Start-up device G2 1/2i
K-MT 35 - 60	VASF5/K35-K60	Fine filter muffler	K-MT 10 - 95	VASRGR/K10-K95	Regeneration gas return
K-MT 75 - 95	VASF5/K75-K95	Fine filter muffler	K-MT 10 - 95	VASNOZ/K1-K95	Nozzle kit

KE-MT 10-95 Series



GENERATION 1

From 04/2007 to 07/2011

For the maintenance of this product range, 12/36, 24 and 48 month service-kits are required, together with other components referenced below. Furthermore a 48 month maintenance interval requires an exchange of desiccant (see DESPACs).

12 and 36 month interval

Material required: Service-kit, filter elements, silencer
 Service-kit contents: Re-set module, pilot valves
 Options: Dew point sensor ZHM 100/450

KE-MT	Material required - PMC Order-No.			Options - PMC Order-No.	
Model	Service-kit	Filter-element	Silencer	Others	
KE-MT 10 - 25	KE-MT12A	See replacement filter elements on opposite page	SDD-25/AL	ZHM100/450	
KE-MT 35 - 60			SDD-40/AL		
KE-MT 75 - 95			SDD-50/AL		

24 and 48 month interval

Material required: Service-kit, silencer, filter elements
 48 month interval: Additional DESMIX (see on opposite page)
 Service-kit contents: Re-set module, wear part sets for in-/outlet valves and non-return valves, o-ring sets (in-/external) for solenoid valve block
 Options: Dew point sensor ZHM100/450

KE-MT	Material required - PMC Order-No.			Options - PMC Order-No.	
Model	Service-kit	Filter-element	Silencer	Others	
KE-MT 10 - 25	KE-MT24A	See replacement filter elements on opposite page	SDD-25/AL	ZHM100/450	
KE-MT 35 - 60	KE-MT24B		SDD-40/AL		
KE-MT 75 - 95			SDD-50/AL		

KE-MT 10-95 Series

GENERATION 1
From 04/2007 to 07/2011



DESMIX

48 month interval

DESMIX content: Molecular sieve in 1 kg, 4 kg, 15 kg or 140 kg packs and dust sieves

Model	PMC Order-No.	Model	PMC Order-No.
KE-MT 10	KE-MT10DESMIX	KE-MT 35	KE-MT35DESMIX
KE-MT 15	KE-MT15DESMIX	KE-MT 45 - 60	KE-MT60DESMIX
KE-MT 20	KE-MT20DESMIX	KE-MT 75	KE-MT75DESMIX
KE-MT 25	KE-MT25DESMIX	KE-MT 95	KE-MT95DESMIX

Replacement filter elements for pre- and after filters

KE-MT	PMC Order-No.		KE-MT	PMC Order-No.	
Model	Filter size	Element grade V, ZP, XP, A	Model	Filter size	Element grade V, ZP, XP, A
KE-MT 10	G9	2010_	KE-MT 40	G12	2030_
KE-MT 15	G9	2010_	KE-MT 45	G12	2030_
KE-MT 20	G11	2020_	KE-MT 60	G13	2050_
KE-MT 25	G11	2020_	KE-MT 75	G14	3050_
KE-MT 35	G12	2030_	KE-MT 95	G14	3050_

The underscore_ should be replaced by the element grade required. Example Filter G9XP containing filter-element 2010XP.

Loose accessories

Suitable for	PMC Order No.	Use	Suitable for	PMC Order No.	Use
KE-MT10 - 95	VASPDP/K1-K95	Dew point measurement	KE-MT10 - 25	VASVPB/K10-K20/25	Start-up device G1i
KE-MT10 - 95	VASMBS420	Signal duplicator 4-20 mA	KE-MT35 - 60	VASVPB/K25-K40/40	Start-up device G1 1/2i
KE-MT10 - 15	VASF5/K10-K15	Fine filter muffler	KE-MT75 - 95	VASVPB/K60-K75/50	Start-up device G2i
KE-MT20 - 25	VASF5/K20-K25	Fine filter muffler	KE-MT 0 - 95	VASRGR/K10-K95	Regeneration gas return
KE-MT35 - 60	VASF5/K35-K60	Fine filter muffler	KE-MT10 - 95	VASNOZ/K1-K95	Nozzle kit
KE-MT75 - 95	VASF5/K75-K95	Fine filter muffler			

KEN-MT 200-1400 Series

GENERATION 0

From 5/2003 to 04/2007



For the maintenance of this product range, 12/36, 24 and 48 month service-kits are required, together with other components referenced below. Furthermore a 48 month maintenance interval requires an exchange of desiccant (see DESMIX).

12 and 36 month interval

Material required: Service-kit, filter elements, silencer
 Service-kit contents: Re-set module, pilot valves
 Options: Dew point sensor ZHM 100/450

KEN-MT	Material required - PMC Order-No.			Options - PMC Order-No.	
Model	Service-kit	Filter-element	Silencer	Others	
KEN-MT 200 - 500	KEN-MT12A	See replacement filter elements on opposite page	SDD-25/AL	ZHM100/450	
KEN-MT 600 - 1150			SDD-40/AL		
KEN-MT 1400			SDD-50/AL		

24 and 48 month interval

Material required: Service-kit, silencer, filter elements
 48 month interval: Additional DESMIX (see on opposite page)
 Service-kit contents: Re-set module, wear part sets for in-/outlet valves and non-return valves, o-ring sets (in-/external) for solenoid valve block, pilot valves, solenoid coils 230V
 Options: Dew point sensor ZHM100/450

KEN-MT	Material required - PMC Order-No.			Options - PMC Order-No.	
Model	Service-kit	Filter-element	Silencer	Others	
KEN-MT 200 - 500	KEN-MT24A	See replacement filter elements on opposite page	SDD-25/AL	ZHM100/450	
KEN-MT 600 - 1150	KEN-MT24B		SDD-40/AL		
KEN-MT 1400			SDD-50/AL		

KEN-MT 200-1400 Series

GENERATION 0
From 5/2003 to 04/2007



DESMIX

48 month interval

DESMIX content: Molecular sieve in 1 kg, 4 kg, 15 kg or 140 kg packs and dust sieves

Model	PMC Order-No.	Model	PMC Order-No.
KEN-MT 200	KEN200DESMIX	KEN-MT 600	KEN600DESMIX
KEN-MT 300	KEN300DESMIX	KEN-MT 800	KEN800DESMIX
KEN-MT 400	KEN400DESMIX	KEN-MT 1150	KEN1150DESMIX
KEN-MT 500	KEN500DESMIX	KEN-MT 1400	KEN1400DESMIX

Replacement filter elements for pre- and after filters

KEN-MT	PMC Order-No.		KEN-MT	PMC Order-No.	
Model	Filter size	Element grade V, ZP, XP, A	Model	Filter size	Element grade V, ZP, XP, A
KEN-MT 200	G9	2010_	KEN-MT 600	G12	2030_
KEN-MT 300	G9	2010_	KEN-MT 800	G12	2030_
KEN-MT 400	G11	2020_	KEN-MT 1150	G13	2050_
KEN-MT 500	G11	2020_	KEN-MT 1400	G14	3050_

The underscore_ should be replaced by the element grade required. Example Filter G9XP containing filter-element 2010XP.

Loose accessories

Suitable for	PMC Order No.	Use	Suitable for	PMC Order No.	Use
KEN-MT 200 - 400	VASPDP/K1-K95	Dew point measurement	KEN-MT 200 - 500	VASVPB/K10-K20/25	Start-up device G1i
KEN-MT 200 - 1400	VASMBS420	Signal duplicator 4-20 mA	KEN-MT 600 - 1150	VASVPB/K25-K40/40	Start-up device G1 1/2i
KEN-MT 200 - 300	VASF5S/K10-K15	Fine filter muffler	KEN-MT 1400	VASVPB/K60-K75/50	Start-up device G2i
KEN-MT 400 - 500	VASF5S/K20-K25	Fine filter muffler	KEN-MT 200 - 1400	VASRGR/K10-K95	Reg.-gas return
KEN-MT 600 - 1150	VASF5S/K35-K60	Fine filter muffler	KEN-MT 200 - 1400	VASNOZ/K1-K95	Nozzle kit
KEN-MT 1400	VASF5S/K75-K95	Fine filter muffler			

KEN-MT 200-1400 Series



GENERATION -1

From 9/2001 to 5/2003

For the maintenance of this product range, 12/36, 24 and 48 month service-kits are required, together with other components referenced below. Furthermore a 48 month maintenance interval requires an exchange of desiccant (see DESMIX).

Update-Kit Multitronic

Suitable for	PMC Order-No.	Replaceable contents
KEN 200 to KEN 1400	UKMT-230-ZHM	Multitronic + ZHM100 + Cable + Measuring chamber
KEN 200 to KEN 1400	UKMT-230	Multitronic + Cable
After upgrading to the current control Multitronic the service-kits of the Generation 0 are required		

12 and 36 month interval

Material required: Service-kit, filter elements, silencer
 Service-kit contents: Pilot valves, indicator beads orange
 Options: Dew point sensor ZHM 100/450

KEN	Material required - PMC Order-No.			Options - PMC Order-No.	
Model	Service-kit	Filter-element	Silencer	Others	
KEN 200 - 500	KEN12A	see replacement filter elements on opposite page	SDD-25/AL	ZHM100/450	
KEN 600 - 1150			SDD-40/AL		
KEN 1400			SDD-50/AL		

24 and 48 month interval

Material required: Service-kit, silencer, filter elements
 48 month interval: Additional DESMIX (see on opposite page)
 Service-kit contents: Wear part sets for in-/outlet valves and non-return valves, o-ring set (internal) for solenoid valve block, pilot valves, solenoid coils 230V, indicator beads orange
 Options: Dew point sensor ZHM100/450

KEN	Material required - PMC Order-No.			Options - PMC Order-No.	
Model	Service-kit	Filter-element	Silencer	Others	
KEN 200 - 500	KEN24A	see replacement filter elements on opposite page	SDD-25/AL	ZHM100/450	
KEN 600 - 1150	KEN24B		SDD-40/AL		
KEN 1400			SDD-50/AL		

KEN-MT 200-1400 Series

GENERATION -1

From 9/2001 to 5/2003



DESMIX

48 month interval

DESMIX content: Molecular sieve in 1 kg, 4 kg, 15 kg or 140 kg packs and dust sieves

Model	PMC Order-No.	Model	PMC Order-No.
KEN 200	KEN200DESMIX	KEN 600	KEN600DESMIX
KEN 300	KEN300DESMIX	KEN 800	KEN800DESMIX
KEN 400	KEN400DESMIX	KEN 1150	KEN1150DESMIX
KEN 500	KEN500DESMIX	KEN 1400	KEN1400DESMIX

Replacement filter elements for pre- and after filters

KEN	PMC Order-No.		KEN	PMC Order-No.	
Model	Filter size	Element grade V, ZP, XP, A	Model	Filter size	Element grade V, ZP, XP, A
KEN 200	G9	2010_	KEN 600	G12	2030_
KEN 300	G9	2010_	KEN 800	G12	2030_
KEN 400	G11	2020_	KEN 1150	G13	2050_
KEN 500	G11	2020_	KEN 1400	G14	3050_

The underscore_ should be replaced by the element grade required. Example Filter G9XP containing filter-element 2010XP.

Loose accessories

Suitable for	PMC Order No.	Use	Suitable for	PMC Order No.	Use
KEN 200 - 400	VASPDP/K1-K95	Dew point measurement	KEN 200 - 500	VASVPB/K10-K20/25	Start-up device G1i
KEN 200 - 1400	VASMBS420	Signal duplicator 4-20 mA	KEN 600 - 1150	VASVPB/K25-K40/40	Start-up device G1 1/2i
KEN 200 - 300	VASF55/K10-K15	Fine filter muffler	KEN 1400	VASVPB/K60-K75/50	Start-up device G2i
KEN 400 - 500	VASF55/K20-K25	Fine filter muffler	KEN 200 - 1400	VASRGR/K10-K95	Regeneration gas return
KEN 600 - 1150	VASF55/K35-K60	Fine filter muffler	KEN 200 - 1400	VASNOZ/K1-K95	Nozzle kit
KEN 1150 - 1400	VASF55/K75-K95	Fine filter muffler			

KE-MT 120-600 Series



GENERATION 1 B

From 04/2007 to the present day

For the maintenance of this product range, 12/36, 24 and 48 month service-kits are required, together with other components referenced below. Furthermore a 48 month maintenance interval requires an exchange of desiccant (see DESMIX).

12 and 36 month interval

Material required: Service-kit, filter elements, silencer
 Service-kit contents: Re-set module, pilot valves, control air filter-element
 Options: Dew point sensor ZHM 100/450

KEN-MT	Material required - PMC Order-No.			Options - PMC Order-No.	
Model	Service-kit	Filter-element	Silencer	Others	
KE-MT 120 - 600	KE-MT12B	see replacement filter elements on opposite page	SDD-25/AL	ZHM100/450	

24 month interval

Material required: Service-kit, filter elements, silencer
 Service-kit contents: Re-set module, wear part sets for in-/outlet-valves, pilot valves, control air filter-element
 Options: Dew point sensor ZHM 100/450

KEN-MT	Material required - PMC Order-No.			Options - PMC Order-No.	
Model	Service-kit	Filter-element	Silencer	Others	
KE-MT 120	KE-MT24F	see replacement filter elements on opposite page	2xSDD-40/AL	ZHM100/450	
KE-MT 150 - 250	KE-MT24C		2xSDD-50/AL		
KE-MT 300 - 500	KE-MT24D		2xSDD-50/AL		
KE-MT 600	KE-MT24E		2xSDD-80/AL		

48 month interval

Material required: Service-kit, filter elements, silencer
 Service-kit contents: Re-set module, wear part sets for in-/outlet-valves, pilot valves, control air filter-element
 Options: Dew point sensor ZHM 100/450

KEN-MT	Material required - PMC Order-No.			Options - PMC Order-No.	
Model	Service-kit	Filter-element	Silencer	Others	
KE-MT 120	KE-MT48F	see replacement filter elements on opposite page	2xSDD-40/AL	ZHM100/450	
KE-MT 150 - 250	KE-MT48C		2xSDD-50/AL		
KE-MT 300 - 500	KE-MT48D		2xSDD-50/AL		
KE-MT 600	KE-MT48E		2xSDD-80/AL		

KE-MT 120-600 Series

GENERATION 1 B

From 04/2007 to the present day



DESMIX

48 month interval

DESMIX content: Molecular sieve in 1 kg, 4 kg, 15 kg or 140 kg packs and dust sieves and GASKIT

Model	PMC Order-No.	Model	PMC Order-No.
KE-MT 120	KEN2000DESMIX	KE-MT 300	KEN5000DESMIX
KE-MT 150	KEN2600DESMIX	KE-MT 380	KEN6000DESMIX
KE-MT 200	KEN3100DESMIX	KE-MT 500	KEN8000DESMIX
KE-MT 250	KEN3800DESMIX	KE-MT 600	KEN10000DESMIX

GASKIT (already included in the DESMIX packs)

GASKIT content: 12 flat gaskets acc. to nominal diameters

Model	DN	PMC Order-No.	Model	DN	PMC Order-No.
KE-MT 120	50	GASKIT50	KE-MT 380 - 500	100	GASKIT100
KE-MT 150 - 200	65	GASKIT65	KE-MT 600	125	GASKIT125
KE-MT 250 - 300	80	GASKIT80			

Replacement filter elements for pre- and after filters (until 03/2013)

KEN	PMC Order-No.		KEN	PMC Order-No.	
Model	Filter size	Element grade V, ZP, XP, A	Model	Filter size	Element grade V, ZP, XP, A
KE-MT 120	G17	3075_	KE-MT 300	F20	2x 3075_
KE-MT 150	G17	3075_	KE-MT 380	F20	2x 3075_
KE-MT 200	G18	5060_	KE-MT 500	F30	3x 3075_
KE-MT 250	G19	5075_	KE-MT 600	F40	4x 3075_

The underscore_ should be replaced by the element grade required. Example: Filter G17XP containing filter-element 3075XP resp. F20 with filter elements 2x 3075XP.

Pre- and after filter are not included in the scope of supply of the dryers, therefore the filter sizes are only informative.

Replacement filter elements for pre- and after filters (from 04/2013)

KEN	PMC Order-No.		KEN	PMC Order-No.	
Model	Filter size	Element grade VL, ZL, XL, A	Model	Filter size	Element grade VL, ZL, XL, A
KE-MT 120	FL17	1x CPS4060_	KE-MT 300	FL20	2x CPS4060_
KE-MT 150	FL17	1x CPS4060_	KE-MT 380	FL20	2x CPS4060_
KE-MT 200	FL17	1x CPS4060_	KE-MT 500	FL30	3x CPS4060_
KE-MT 250	FL20	2x CPS4060_	KE-MT 600	FL30	3x CPS4060_

The underscore_ should be replaced by the element grade required. Example: Filter FL20XL with filter elements 2x CPS4060XL

Pre- and after filter are not included in the scope of supply of the dryers, therefore the filter sizes are only informative.

KEN-MT 2000-10000 Series



GENERATION 1 A

From 03/2003 to 4/2007

For the maintenance of this product range, 12/36, 24 and 48 month service-kits are required, together with other components referenced below. Furthermore a 48 month maintenance interval requires an exchange of desiccant (see DESMIX).

12 and 36 month interval

Material required: Service-kit, filter elements, silencer
 Service-kit contents: Re-set module, pilot valves, control air filter-element
 Options: Dew point sensor ZHM 100/450

KEN-MT	Material required - PMC Order-No.			Options - PMC Order-No.	
Model	Service-kit	Filter-element	Silencer	Others	
KEN-MT 2000 - 10000	KEN-MT12D	see replacement filter elements on opposite page	SDD-25/AL	ZHM100/450	

24 month interval

Material required: Service-kit, filter elements, silencer
 Service-kit contents: Re-set module, wear part sets for in-/outlet-valves, pilot valves, control air filter-element
 Options: Dew point sensor ZHM 100/450

KEN-MT	Material required - Order-No.			Options - Order-No.	
Model	Service-kit	Filter-element	Silencer	Others	
KEN-MT 2000 - 3800	KEN-MT24D	See replacement filter elements on opposite page	2xSDD-50/AL	ZHM100/450	
KEN-MT 5000 - 8000	KEN-MT24E		4xSDD-50/AL		
KEN-MT 10000	KEN-MT24F		4xSDD-80/AL		

48 month interval

Material required: Service-kit, filter elements, silencer
 Service-kit contents: Re-set module, wear part sets for in-/outlet-valves, pilot valves, control air filter-element
 Options: Dew point sensor ZHM 100/450

KEN-MT	Material required - Order-No.			Options - Order-No.	
Model	Service-kit	Filter-element	Silencer	Others	
KEN-MT 2000 - 3800	KEN-MT48D	See replacement filter elements on opposite page	2xSDD-50/AL	ZHM100/450	
KEN-MT 5000 - 8000	KEN-MT48E		4xSDD-50/AL		
KEN-MT 10000	KEN-MT48F		4xSDD-80/AL		

KEN-MT 2000-10000 Series

GENERATION 1 A
From 03/2003 to 4/2007



DESMIX

48 month interval

DESMIX content: Molecular sieve in 1 kg, 4 kg, 15 kg or 140 kg packs and dust sieves and GASKIT

Model	PMC Order-No.	Model	PMC Order-No.
KEN-MT 2000	KEN2000DESMIX	KEN-MT 5000	KEN5000DESMIX
KEN-MT 2600	KEN2600DESMIX	KEN-MT 6000	KEN6000DESMIX
KEN-MT 3100	KEN3100DESMIX	KEN-MT 8000	KEN8000DESMIX
KEN-MT 3800	KEN3800DESMIX	KEN-MT 10000	KEN10000DESMIX

GASKIT (already included in the DESMIX packs)

GASKIT content: 12 flat gaskets acc. to nominal diameters

Model	DN	PMC Order-No.	Model	DN	PMC Order-No.
KEN-MT 2000	50	GASKIT50	KE-MT 380 - 500	100	GASKIT100
KEN-MT 2600-3100	65	GASKIT65	KE-MT 600	125	GASKIT125
KEN-MT 3800-5000	80	GASKIT80			

Replacement filter elements for pre- and after filters

KEN-MT			KEN-MT		
Model	Filter size	Element grade V, ZP, XP, A	Model	Filter size	Element grade V, ZP, XP, A
KEN-MT 2000	G17	3075_	KEN-MT 5000	F20	2x 3075_
KEN-MT 2600	G17	3075_	KEN-MT 6000	F20	2x 3075_
KEN-MT 3100	G18	5060_	KEN-MT 8000	F30	3x 3075_
KEN-MT 3800	G19	5075_	KEN-MT 10000	F40	4x 3075_

The underscore_ should be replaced by the element grade required. Example: Filter G17XP containing filter-element 3075XP resp. F20 with filter elements 2x 3075XP.

Pre- and after filter are not included in the scope of supply of the dryers, therefore the filter sizes are only informative.



KEN 2000-10000 Series

GENERATION 0

From 09/2001 to 9/2003

For the maintenance of this product range, 12/36, 24 and 48 month service-kits are required, together with other components referenced below. Furthermore a 48 month maintenance interval requires an exchange of desiccant (see DESMIX).

Update-Kit Multitronic

Suitable for	PMC Order-No.	Replaceable contents
KEN 2000 - 10000	UKMT-230-ZHM	Multitronic + ZHM100 + Cable + Measuring chamber
KEN 2000 - 10000	UKMT-230	Multitronic + Cable

After upgrading to the current control Multitronic the service-kits of the Generation 0 are required.

12 and 36 month interval

Material required: Service-kit, filter elements, silencer
 Service-kit contents: Pilot valves, control air filter element, indicator beads
 Options: Dew point sensor ZHM 100/450

KEN	Material required - PMC Order-No.			Options - PMC Order-No.	
Model	Service-kit	Filter-element	Silencer	Others	
KEN 2000 - 10000	KEN12D	See replacement filter elements on opposite page	siehe Intervall 24/48 Monate	ZHM100/450	

24 month interval

Material required: Service-kit, filter elements, silencer
 Service-kit contents: Wear part sets for in-/outlet-valves, pilot valves, control air filter-element, indicator beads
 Options: Dew point sensor ZHM 100/450

KEN	Material required - PMC Order-No.			Options - PMC Order-No.	
Model	Service-kit	Filter-element	Silencer	Others	
KEN 2000 - 3800	KEN24D	See replacement filter elements on opposite page	2xSDD-50/AL	ZHM100/450	
KEN 5000 - 8000	KEN24E		4xSDD-50/AL		
KEN 10000	KEN24F		4xSDD-80/AL		

48 month interval

Material required: Service-kit, filter elements, silencer
 Service-kit contents: Control air filter-element, wear part sets for in-/outlet-valves, solenoid valve block, indicator beads
 Options: Dew point sensor ZHM 100/450

KEN	Material required - PMC Order-No.			Options - PMC Order-No.	
Model	Service-kit	Filter-element	Silencer	Others	
KEN 2000 - 3800	KEN48D	See replacement filter elements on opposite page	2xSDD-50/AL	ZHM100/450	
KEN 5000 - 8000	KEN48E		4xSDD-50/AL		
KEN 10000	KEN48F		4xSDD-80/AL		

KEN 2000-10000 Series

GENERATION 0
From 09/2001 to 9/2003



DESMIX

48 month interval

DESMIX content: Molecular sieve in 1 kg, 4 kg, 15 kg or 140 kg packs and dust sieves and GASKIT

Model	PMC Order-No.	Model	PMC Order-No.
KEN 2000	KEN2000DESMIX	KEN 5000	KEN5000DESMIX
KEN 2600	KEN2600DESMIX	KEN 6000	KEN6000DESMIX
KEN 3100	KEN3100DESMIX	KEN 8000	KEN8000DESMIX
KEN 3800	KEN3800DESMIX	KEN 10000	KEN10000DESMIX

GASKIT (already included in the DESMIX packs)

GASKIT content: 12 flat gaskets acc. to nominal diameters

Model	DN	PMC Order-No.	Model	DN	PMC Order-No.
KEN 2000	50	GASKIT50	KEN 6000 - 8000	100	GASKIT100
KEN 2600 - 3100	65	GASKIT65	KEN 10000	125	GASKIT125
KEN 3800 - 5000	80	GASKIT80			

Replacement filter elements for pre- and after filters

KEN-MT	PMC Order-No.		KEN-MT	PMC Order-No.	
Model	Filter size	Element grade V, ZP, XP, A	Model	Filter size	Element grade V, ZP, XP, A
KEN 2000	G17	3075_	KEN 5000	F20	2x 3075_
KEN 2600	G17	3075_	KEN 6000	F20	2x 3075_
KEN 3100	G18	5060_	KEN 8000	F30	3x 3075_
KEN 3800	G19	5075_	KEN 10000	F40	4x 3075_

The underscore_ should be replaced by the element grade required. Example: Filter G17XP containing filter-element 3075XP resp. F20 with filter elements 2x 3075XP.

Pre- and after filter are not included in the scope of supply of the dryers, therefore the filter sizes are only informative.

Heatless Adsorption Dryers

KA-MT 1-8, KA-MT 1-8,
KMA 5-115 Series





KA-MT 1-8 Series

GENERATION 3 (OIL-X filter)

From 01/2019 to the present day

For the maintenance of this product range, 12/36, 24 and 48 month service-kits are required, together with other components referenced below. Furthermore a 48 month maintenance interval requires an exchange of desiccant (see DESPACs). When the oil-control indicator shows that activated carbon replacement is required or at least after 12 months operation, this must be carried out. Independent of the level of discolouration in the indicator-tube (P02/ZR), the oil-control indicator must also be replaced.

12 and 36 month interval

Material required: Service-kit, DESPACs see on opposite page
 Service-kit contents: Re-set module, silencers, filter elements, perforated plates
 Options: Dew-point sensor ZHM100/450, Indicator-tube P02/ZR

KA-MT	Material required - PMC Order-No.			Options - PMC Order-No.	
Product Code	Service-kit			Others	
KA-MT 1 - 4	SKK1-K4/DA3/12			ZHM100/450	P02/ZR
KA-MT 6 - 7	SKK6-K7/DA3/12				
KA-MT 8	SKK8/DA3/12				

24 month interval

Material required: Service-kit, DESPACs see on opposite page
 Service-kit contents: Re-set module, silencers, filter elements, wear part set for in- and outlet-valves
 Options: Dew-point sensor ZHM100/450, indicator-tube P02/ZR

KA-MT	Material required - PMC Order-No.			Options - PMC Order-No.	
Product Code	Service-kit			Others	
KA-MT 1 - 4	SKK1-K4/DA3/24			ZHM100/450	P02/ZR
KA-MT 6 - 7	SKK6-K7/DA3/24				
KA-MT 8	SKK8/DA3/24				

48 month interval

Material required: Service-kit, DESPACs see on opposite page
 Service-kit contents: Re-set module, silencers, filter elements, perforated plates, perforated plate gaskets, solenoid coils 230V, wear part set for in- and outlet-valves, non-return-valves, 2 demister pads.
 Options: Dew-point sensor ZHM100/450, indicator-tube P02/ZR

KA-MT	Material required - PMC Order-No.			Options - PMC Order-No.	
Product Code	Service-kit			Others	
KA-MT 1 - 4	SKK1-K4/DA3/48			ZHM100/450	P02/ZR
KA-MT 6 - 7	SKK6-K7/DA3/48				
KA-MT 8	SKK8/DA3/48				

Options : coils only for 50Hz (398H254061)

KA-MT 1-8 Series

GENERATION 3 (OIL-X filter)
From 01/2019 to the present day



DESPACs

12, 24, 36, 48 month interval

Content DESPACs: Activated carbon in 3 kg or 10 kg packs

PMC Order-No.	KA-MT 1	KA-MT 2	KA-MT 3	KA-MT 4	KA-MT 6	KA-MT 7	KA-MT 8
DESPAC3AK	1	1	1	1	2	2	
DESPAC10AK							1

48 month interval

Content DESPACs: Molecular sieve in 1 kg, 4 kg or 15 kg packs

PMC Order-No.	KA-MT 1	KA-MT 2	KA-MT 3	KA-MT 4	KA-MT 6	KA-MT 7	KA-MT 8
DESPAC1MS	1		1		1		
DESPAC4MS		1	1	2	3	4	1
DESPAC15MS							1

Replacement filter elements for pre- and after filters (filter elements are included in the service-kit)

K-MT	PMC Order-No.			
Product code	Upstream filter	Element grade	Downstream filter	Element grade
KA-MT 1	AAP010AGFI	P010AA	AOP010AGMI	P010AO
KA-MT 2	AAP010AGFI	P010AA	AOP010AGMI	P010AO
KA-MT 3	AAP010AGFI	P010AA	AOP010AGMI	P010AO
KA-MT 4	AAP010AGFI	P010AA	AOP010AGMI	P010AO
KA-MT 6	AAP015AGFI	P015AA	AOP015AGMI	P015AO
KA-MT 7	AAP015AGFI	P015AA	AOP015AGMI	P015AO
KA-MT 8	AAP020AGFI	P020AA	AOP020AGMI	P020AO

The code spacing_ should contain the filter-element grade required. Example: Filter AAP010AGFI containing filter-element P010AA.

Loose accessories

Suitable for	PMC Order-No.	Use	Suitable for	PMC Order-No.	Use
KA-MT 1 - 8	VASRGR/K1-K8	Purge air return-line	KA-MT 1 - 4	VASVPB/K1-K4/08	Starting device G1/4i
KA-MT 1 - 95	VASDPD/K1-K95	Dew-point measurement	KA-MT 6 - 7	VASVPB/K6-K7/15	Starting device G1/2i
KA-MT 1 - 95	VASMBS420	Signal Splitter 4-20mA	KA-MT 8	VASVPB/K8/20	Starting device G3/4i
KA-MT 1 - 95	VASNOZ/K1-K95	Nozzle-kit	KA-MT 1 - 4	VASFS3/K1-K4	Fine filter silencer
KA-MT 1 - 8	VASSDD08/15	Filter silencer	KA-MT 6 - 8	VASFS5/K6-K8	Fine filter silencer



KA-MT 1-8 Series

GENERATION 2

From 07/2011 to 12/2018

For the maintenance of this product range, 12/36, 24 and 48 month service-kits are required, together with other components referenced below. Furthermore a 48 month maintenance interval requires an exchange of desiccant (see DESPACs). When the oil-control indicator shows that activated carbon replacement is required or at least after 12 months operation, this must be carried out. Independent of the level of discolouration in the indicator-tube (P02/ZR), the oil-control indicator must also be replaced.

12 and 36 month interval

Material required: Service-kit, DESPACs see on opposite page
 Service-kit contents: Re-set module, silencers, filter elements, perforated plates
 Options: Dew-point sensor ZHM100/450, Indicator-tube P02/ZR

KA-MT	Material required - PMC Order-No.			Options - PMC Order-No.	
Product Code	Service-kit			Others	
KA-MT 1 - 4	SKK1-K4/DA2/12			ZHM100/450	P02/ZR
KA-MT 6 - 7	SKK6-K7/DA2/12				
KA-MT 8	SKK8/DA2/12				

24 month interval

Material required: Service-kit, DESPACs see on opposite page
 Service-kit contents: Re-set module, silencers, filter elements, wear part set for in- and outlet-valves
 Options: Dew-point sensor ZHM100/450, indicator-tube P02/ZR

KA-MT	Material required - PMC Order-No.			Options - PMC Order-No.	
Product Code	Service-kit			Others	
KA-MT 1 - 4	SKK1-K4/DA2/24			ZHM100/450	P02/ZR
KA-MT 6 - 7	SKK6-K7/DA2/24				
KA-MT 8	SKK8/DA2/24				

48 month interval

Material required: Service-kit, DESPACs see on opposite page
 Service-kit contents: Re-set module, silencers, filter elements, perforated plates, perforated plate gaskets, solenoid coils 230V, wear part set for in- and outlet-valves, non-return-valves, 2 demister pads.
 Options: Dew-point sensor ZHM100/450, indicator-tube P02/ZR

KA-MT	Material required - PMC Order-No.			Options - PMC Order-No.	
Product Code	Service-kit			Others	
KA-MT 1 - 4	SKK1-K4/DA2/48			ZHM100/450	P02/ZR
KA-MT 6 - 7	SKK6-K7/DA2/48				
KA-MT 8	SKK8/DA2/48				

KA-MT 1-8 Series

GENERATION 2

From 07/2011 to 12/2018



DESPACs

12, 24, 36, 48 month interval

Content DESPACs: Activated carbon in 3 kg or 10 kg packs

PMC Order-No.	KA-MT 1	KA-MT 2	KA-MT 3	KA-MT 4	KA-MT 6	KA-MT 7	KA-MT 8
DESPAC3AK	1	1	1	1	2	2	
DESPAC10AK							1

48 month interval

Content DESPACs: Molecular sieve in 1 kg, 4 kg or 15 kg packs

PMC Order-No.	KA-MT 1	KA-MT 2	KA-MT 3	KA-MT 4	KA-MT 6	KA-MT 7	KA-MT 8
DESPAC1MS	1		1		1		
DESPAC4MS		1	1	2	3	4	1
DESPAC15MS							1

Replacement filter elements for pre- and after filters (filter elements are included in the service-kit)

K-MT	PMC Order-No.		K-MT	PMC Order-No.	
Product code	Filter housing size	Element grade VL, ZL, XL, A	Product code	Filter housing size	Element grade VL, ZL, XL, A
KA-MT 1	GL2	CP1008_	KA-MT 6	GL5	CP2010_
KA-MT 2	GL2	CP1008_	KA-MT 7	GL5	CP2010_
KA-MT 3	GL2	CP1008_	KA-MT 8	GL7	CP2020_
KA-MT 4	GL2	CP1008_			

The code spacing_ should contain the filter-element grade required. Example: Filter GL2XL containing filter-element CP1008XL.

Loose accessories

Suitable for	PMC Order-No.	Use	Suitable for	PMC Order-No.	Use
KA-MT 1 - 8	VASRGR/K1-K8	Purge air return-line	KA-MT 1 - 4	VASVPB/K1-K4/08	Starting device G1/4i
KA-MT 1 - 95	VASDPD/K1-K95	Dew-point measurement	KA-MT 6 - 7	VASVPB/K6-K7/15	Starting device G1/2i
KA-MT 1 - 95	VASMBS420	Signal Splitter 4-20mA	KA-MT 8	VASVPB/K8/20	Starting device G3/4i
KA-MT 1 - 95	VASNOZ/K1-K95	Nozzle-kit	KA-MT 1 - 4	VASFS3/K1-K4	Fine filter silencer
KA-MT 1 - 8	VASSDD08/15	Filter silencer	KA-MT 6 - 8	VASFS5/K6-K8	Fine filter silencer



KA-MT 1-8 Series

GENERATION 1

From 05/2003 to 06/2011

For the maintenance of this product range, 12/36, 24 and 48 month service-kits are required, together with other components referenced below. Furthermore a 48 month maintenance interval requires an exchange of desiccant (see DESPACs). When the oil-control indicator shows that activated carbon replacement is required or at least after 12 months operation, this must be carried out. Independent of the level of discolouration in the indicator-tube (P02/ZR), the oil-control indicator must also be replaced.

12 and 36 month interval

Material required: Service-kit, perforated plate gaskets (RKA), filter-element, silencer, DESPACs

Service-kit contents: Re-set module

Service-kit contents RKA: Filter elements for after-filter, 2x perforated plate gaskets with foamed seals

Options: Dew-point sensor ZHM 100/450, indicator-tube P02/ZR

KA-MT	Material required - PMC Order-No.			Options - PMC Order-No.		
Product Code	Service-kit		Filter-element	Silencer	Others	
KA-MT 1 - 4	K-MT12A	RKA1-A4	See replacement filter elements on opposite page	VASSDD08/15	ZHM100/450	P02/ZR
KA-MT 6- 8	K-MT12A	RKA6-A8				

24 month interval

Material required:

Service-kit, perforated plate gaskets (RKA) silencers, filter elements, DESPACs see opposite page

Service-kit contents

Re-set module, wear part set for in- and outlet-valves

Service-kit contents RKA:

Filter elements for after-filter, 2 x perforated plate gaskets with foamed seals

Options:

Dew-point sensor ZHM100/450, indicator-tube P02/ZR

KA-MT	Material required - PMC Order-No.			Options - PMC Order-No.		
Product Code	Service-kit		Filter-element	Silencer	Others	
KA-MT 1 - 4	K-MT24A	RKA1-A4	See replacement filter elements on opposite page	VASSDD08/15	ZHM100/450	P02/ZR
KA-MT 6 - 8		RKA6-A8				

48 month interval

Material required:

Service-kit, silencer, filter elements, DESPACs see on opposite page

Service-kit contents:

Re-set module, perforated plates, perforated plate gaskets, solenoid coils 230V, wear part set for in-/outlet-valves, non-return valves, 2 Demisters

Options:

Dew point sensor ZHM100/450

K-MT	Material required -PMC Order-No.			Options - PMC Order-No.		
Product Code	Service-kit		Filter-element	Silencer	Others	
K-MT 1 - 4	K-MT48A	RKA1-A4	See replacement filter elements on opposite page	VASSDD08/15	ZHM100/450	P02/ZR
K-MT 6 - 8	K-MT48B	RKA6-A8				

KA-MT 1-8 Series

GENERATION 1

From 05/2003 to 06/2011



DESPACs

12, 24, 36, 48 month interval

Content DESPACs: Activated carbon in 3 kg or 10 kg packs

PMC Order-No.	KA-MT 1	KA-MT 2	KA-MT 3	KA-MT 4	KA-MT 6	KA-MT 7	KA-MT 8
DESPAC3AK	1	1	1	1	2	2	
DESPAC10AK							1

48 month interval

Content DESPACs: Molecular sieve in 1 kg, 4 kg or 15 kg packs

PMC Order-No.	KA-MT 1	KA-MT 2	KA-MT 3	KA-MT 4	KA-MT 6	KA-MT 7	KA-MT 8
DESPAC1MS	1		1		1		
DESPAC4MS		1	1	2	3	4	1
DESPAC15MS							1

Replacement filter elements for pre- and after filters

KA-MT	PMC Order-No.		KA-MT	PMC Order-No.	
Product code	Filter housing size	Element grade VL, ZL, XL, A	Product code	Filter housing size	Element grade VL, ZL, XL, A
KA-MT 1	G2	1030_	KA-MT 6	G5	1070_
KA-MT 2	G2	1030_	KA-MT 7	G5	1070_
KA-MT 3	G2	1030_	KA-MT 8	G7	1140_
KA-MT 4	G2	1030_			

The code spacing_ should contain the filter-element grade required. Example: Filter G2XP containing filter element 1030XP.

Loose accessories

Suitable for	PMC Order-No.	Use	Suitable for	PMC Order-No.	Use
KA-MT 1 - 8	VASRGR/K1-K8	Purge air return-line	KA-MT 1 - 4	VASVPB/K1-K4/08	Starting device G1/4i
KA-MT 1 - 95	VASDPD/K1-K95	Dew point measurement	KA-MT 6 - 7	VASVPB/K6-K7/10	Starting device G3/8i
KA-MT 1 - 95	VASMBS420	Signal Splitter 4-20 mA	KA-MT 8	VASVPB/K6-K7/15	Starting device G3/4i
KA-MT 1 - 95	VASNOZ/K1-K95	Nozzle-kit	KA-MT 1 - 4	VASFS3/K1-K4	Fine filter silencer
KA-MT 1 - 8	VASSDD08/15	Silencer	KA-MT 6 - 8	VASFS5/K6-K8	Fine filter silencer



KMA 5-115 Series

GENERATION 0

Up to mid. 2003

Generation 0 dryers should be updated once to the latest technical specification using the following retrofit kits.

For the maintenance of this product range, 12/36, 24 and 48 month service-kits are required, together with other components referenced below. Furthermore a 48 month maintenance interval requires an exchange of desiccant (see DESPACs). When the oil-control indicator shows that activated carbon replacement is required or at least after 12 months operation, this must be carried out. Independent of the level of discolouration in the indicator-tube (P02/ZR), the oil-control indicator must also be replaced.

Update-kit

Suitable for	PMC Order-No.	Replaceable contents
KMA 5 - 35	UKKM5-35	Solenoid valve plate incl. seals + cable + socket-coupling
KMA 5 - 35	UKKM5-35/RV	Non-return valve plate incl. seals - without nozzle
KMA 75 - 115	UKKM75-115	Solenoid valve plate incl. seals + cable + socket-coupling
KMA 75 - 115	UKKM75-115/RV	Non-return valve plate incl. seals - without nozzle

Update-kit Multitronic

Suitable for	PMC Order-No.	Replaceable contents
KMA 5 - 115	UKMT-230-ZHM	Multitronic + cable + ZHM100 + measuring chamber
KMA 5 - 115	UKMT-230	Multitronic + cable

After the conversion of the current control Multitronic every 12 month is the following service kit required

KMA 5 - 115	K-MT12A	Reset-modul
-------------	---------	-------------

12 and 36 month interval

Material required: Filter-element, perforated plate gaskets (AKMKIT) silencers, DESPACs

Service-kit contents: -

Service-kit contents AKMKIT: Filter elements for after-filter, 2 x perforated plates gaskets with foamed seals

Options: Dew-point sensor*, indicator-tube P02/ZR

KMA	Material required - PMC Order-No.			Options - PMC Order-No.	
	Service-kit	Filter-element	Silencer	Others	
KMA 5 - 35	RKA1-A4	See replacement filter elements on opposite page	VASSDD08/15	ZHM100/450*	P02/ZR
KMA 75 - 115	AKMKIT2				

* Dew-point sensor can vary in type: Please provide the construction number of the dryer when making an enquiry.

24 month interval

Material required: Service-kit, filter elements, perforated plate gaskets (AKMKIT), silencers, DESPACs see opposite page

Service-kit contents: Wear part set for in- and outlet-valves

Service-kit contents AKMKIT: Filter elements for after-filter, 2 x perforated plate gaskets with foamed seals

Options: Dew-point sensor, indicator-tube P02/ZR

KMA	Material required - PMC Order-No.			Options - PMC Order-No.	
	Service-kit	Filter-element	Silencer	Others	
KMA 5 - 35	KM24A-UG	RKA1-A4	VASSDD08/15	ZHM100/450*	P02/ZR
KMA 75 - 115		AKMKIT2			

* Dew-point sensor can vary in type: Please provide the construction number of the dryer when making an enquiry.

KMA 5-115 Series

GENERATION 0
Up to mid. 2003



48 month interval

Material required: Service-kit, filter elements, silencers, DESPACs see below
 Service-kit contents: Perforated plate gaskets, solenoid coils 230V, wear part set for in- and outlet-valves, non-return valves
 Service-kit contents AK: Filter elements for after-filter, 2 x perforated plates gaskets with foamed seals
 Options: Dew-point sensor, indicator-tube P02/ZR)

KMA	Material required - PMC Order-No.			Options		
	Service-kit	Filter-element	Silencer	Others		
KMA 5 - 35	KM48A-UG	RKA1-A4	See replacement filter elements on opposite page	VASSDD08/15	ZHM100/450*	P02/ZR
KMA 75 - 115	KM48B-UG	AKMKIT2				

* Dew-point sensor can vary in type: Please provide the construction number of the dryer when making an enquiry.

DESPACs

12, 24, 36, 48 month interval

Content DESPACs: Activated carbon in 3 kg or 10 kg packs

PMC Order-No.	KMA 5	KMA 10	KMA 25	KMA 35	KMA 75	KMA 95	KMA 115
DESPAC3AK	1	1	1	1	2	2	
DESPAC10AK							1

48 month interval

Content DESPACs: Molecular sieve in 1 kg, 4 kg or 15 kg packs

PMC Order-No.	KMA 5	KMA 10	KMA 25	KMA 35	KMA 75	KMA 95	KMA 115
DESPAC1MS	1		1		1		
DESPAC4MS		1	1	2	3	4	1
DESPAC15MS							1

Replacement filter elements for pre- and after filters

KMA	PMC Order-No.		K-MT	PMC Order-No.	
Product code	Filter housing size	Element grade V, ZP, XP, A	Product code	Filter housing size	Element grade V, ZP, XP, A
KMA 5	G2	1030_	KMA 75	G5	1070_
KMA 10	G2	1030_	KMA 95	G5	1070_
KMA 25	G2	1030_	KMA 115	G7	1140_
KMA 35	G2	1030_			

The code spacing_ should contain the filter-element grade required. Example: Filter G2XP containing filter element 1030XP.

Heatless Adsorption Dryers

KA-MT 10-95, KA-MT 10-95,
KEA-MT 10-95, KEA 200-1400 Series





KA-MT 10-95 Series

GENERATION 3 (OIL-X filter)

From 01/2019 to the present day

For the maintenance of this product range, 12/36, 24 and 48 month service-kits are required, together with other components referenced below. Furthermore a 48 month maintenance interval requires an exchange of desiccant (see DESMIX). When the oil-control indicator shows that activated carbon replacement is required or at least after 12 months operation, this must be carried out. Independent of the level of discolouration in the indicator-tube (P02/ZR), the oil-control indicator must also be replaced

12 and 36 month interval

Material required: Service-kit, DESPACs see on opposite page
 Service-kit contents: Re-set module, silencers, filter-elements, pilot valves
 Options: Dew-point sensor ZHM100/450, Indicator-tube P02/ZR

KA-MT	Material required - PMC Order-No.		Options - PMC Order-No.	
Model	Service-kit	Mains voltage	Others	
KA-MT 10-20	SKK10-K20/D3/12	115V, 230V	ZHM100/450	P02/ZR
KA-MT 25	SKK25/D3/12	115V, 230V		
KA-MT 35	SKK35/D3/12	115V, 230V		
KA-MT 45	SKK45/D3/12	115V, 230V		
KA-MT 60 - 75	SKK60-K75/D3/12	115V, 230V		
KA-MT 95	SKK95/D3/12	115V, 230V		

24 and 48 month interval

Material required: Service-kit,
 48-month interval: Also DESMIX packs (see on opposite page)
 Service-kit contents: Re-set module, silencer, filter-elements, solenoid coils 230V, wear part set for in- and outlet-valves, non-return-valves, O-ring sets (internal/external) for solenoid valve block
 Options: Dew-point sensor ZHM100/450, Indicator-tube P02/ZR

KA-MT	Material required - PMC Order-No.		Options - PMC Order-No.	
Model	Service-kit	Mains voltage	Others	
KA-MT 10-20	SKK10-K20/D3/24/115	115V	ZHM100/450	P02/ZR
	SKK10-K20/D3/24	230V		
KA-MT 25	SKK25/D3/24/115	115V		
	SKK25/D3/24	230V		
KA-MT 35	SKK35/D3/24/115	115V		
	SKK35/D3/24	230V		
KA-MT 45	SKK45/D3/24/115	115V		
	SKK45/D3/24	230V		
KA-MT 60 - 75	SKK60-K75/D3/24/115	115V		
	SKK60-K75/D3/24	230V		
KA-MT 95	SKK95/D3/24/115	115V		
	SKK95/D3/24	230V		

Options : coils only for 50Hz (398H254061)

KA-MT 10-95 Series

GENERATION 3 (OIL-X filter)
From 01/2019 to the present day

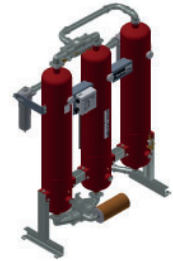

DESPAC

12, 24, 36, 48 month interval

Content DESPAC: Activated carbon in 3 kg or 10 kg packs

PMC Order No.	KA-MT 10	KA-MT 15	KA-MT 20	KA-MT 25	KA-MT 35	KA-MT 45	KA-MT 60	KA-MT 75	KA-MT 95
DESPAC3AK		1	2	1		1			
DESPAC10AK	1	1	1	2	3	3	5	7	9

DESMIX

48 month interval

DESMIX content: Molecular sieve in 1 kg, 4 kg, 15 kg or 140 kg packs

Model		Model	PMC Order-No.
KA-MT 10	K-MT10DESMIX	KA-MT 45	K-MT60DESMIX
KA-MT 15	K-MT15DESMIX	KA-MT 60	K-MT60DESMIX
KA-MT 20	K-MT20DESMIX	KA-MT 75	K-MT75DESMIX
KA-MT 25	K-MT25DESMIX	KA-MT 95	K-MT95DESMIX
KA-MT 35	K-MT35DESMIX		

Replacement filter elements for pre- and after filters (filter elements are included in the service-kit)

K-MT	PMC Order-No.			
	Upstream filter	Element grade	Downstream filter	Element grade
KA-MT 10	AAP025EGFI	P025AA	AOP025EGMI	P025AO
KA-MT 15	AAP025EGFI	P025AA	AOP025EGMI	P025AO
KA-MT 20	AAP025EGFI	P025AA	AOP025EGMI	P025AO
KA-MT 25	AAP030GGFI	P030AA	AOP030GGMI	P030AO
KA-MT 35	AAP030GGFI	P030AA	AOP030GGMI	P030AO
KA-MT 45	AAP035GGFX	P035AA	AOP035GGMX	P035AO
KA-MT 60	AAP040HGFX	P040AA	AOP040HGMX	P040AO
KA-MT 75	AAP040HGFX	P040AA	AOP040HGMX	P040AO
KA-MT 95	AAP045IGFX	P045AA	AOP045IGMX	P045AO

The underscore_ should be replaced by the element grade required. Example Filter AAP035GGFX containing filter-element P035AA.

Loose accessories

Suitable for	PMC Order No.	Use	Suitable for	PMC Order No.	Use
KA-MT 10 - 95	VASDPD/K1-K95	Dew-point measuren.	KA-MT 10 - 20	VASVPB/K10-K20/25	Start-up device G1i
KA-MT 10 - 95	VASMBS420	Signal doppler 4-20 mA	KA-MT 25 - 45	VASVPB/K25-K45/40	Start-up device G1 1/2i
KA-MT 10 - 15	VASF5S/K10-K15	Fine filter silencer	KA-MT 60 - 75	VASVPB/K60-K75/50	Start-up device G2i
KA-MT 20 - 25	VASF5S/K20-K25	Fine filter silencer	KA-MT 95	VASVPB/K95/65	Start-up device G2 1/2i
KA-MT 35 - 60	VASF5S/K35-K60	Fine filter silencer	KA-MT 10 - 75	VASRGR/K10-K75	Regeneration gas recirculation
KA-MT 75 - 95	VASF5S/K75-K95	Fine filter silencer	KA-MT 95	VASRGR/K95	Regeneration gas recirculation
			KA-MT 10 - 95	VASNOZ/K1-K75	Nozzle-kit



KA-MT 10-95 Series

GENERATION 2

From 07/2011 to 12/2018

For the maintenance of this product range, 12/36, 24 and 48 month service-kits are required, together with other components referenced below. Furthermore a 48 month maintenance interval requires an exchange of desiccant (see DESMIX). When the oil-control indicator shows that activated carbon replacement is required or at least after 12 months operation, this must be carried out. Independent of the level of discolouration in the indicator-tube (P02/ZR), the oil-control indicator must also be replaced

12 and 36 month interval

Material required: Service-kit, DESPACs see on opposite page
 Service-kit contents: Re-set module, silencers, filter-elements, pilot valves
 Options: Dew-point sensor ZHM100/450, Indicator-tube P02/ZR

KA-MT	Material required - PMC Order-No.			Options - PMC Order-No.	
Model	Service-kit			Others	
KA-MT 10 - 20	SKK10-K20/D2/12			ZHM100/450	P02/ZR
KA-MT 25	SKK25/D2/12				
KA-MT 35	SKK35/D2/12				
KA-MT 45	SKK45/D2/12				
KA-MT 60 - 75	SKK60-K75/D2/12				
KA-MT 95	SKK95/D2/12				

24 and 48 month interval

Material required: Service-kit,
 48-month interval: Also DESMIX packs (see on opposite page)
 Service-kit contents: Re-set module, silencer, filter-elements, solenoid coils 230V, wear part set for in- and outlet-valves, non-return-valves, O-ring sets (internal/external) for solenoid valve block
 Options: Dew-point sensor ZHM100/450, Indicator-tube P02/ZR

KA-MT	Material required - PMC Order-No.			Options - PMC Order-No.	
Model	Service-kit			Others	
KA-MT 10 - 20	SKK10-K20/D2/24			ZHM100/450	P02/ZR
KA-MT 25	SKK25/D2/24				
KA-MT 35	SKK35/D2/24				
KA-MT 45	SKK45/D2/24				
KA-MT 60 - 75	SKK60-K75/D2/24				
KA-MT 95	SKK95/D2/24				

KA-MT 10-95 Series

GENERATION 2

From 07/2011 to 12/2018



DESPAC

12, 24, 36, 48 month interval

Content DESPAC: Activated carbon in 3 kg or 10 kg packs

PMC Order No.	KA-MT 10	KA-MT 15	KA-MT 20	KA-MT 25	KA-MT 35	KA-MT 45	KA-MT 60	KA-MT 75	KA-MT 95
DESPAC3AK		1	2	1		2			
DESPAC10AK	1	1	1	2	3	3	5	7	9

DESMIX

48 month interval

DESMIX content: Molecular sieve in 1 kg, 4 kg, 15 kg or 140 kg packs

Model	PMC Order-No.	Model	PMC Order-No.
KA-MT 10	K-MT10DESMIX	KA-MT 35	K-MT35DESMIX
KA-MT 15	K-MT15DESMIX	KA-MT 45 - 60	K-MT60DESMIX
KA-MT 20	K-MT20DESMIX	KA-MT 75	K-MT75DESMIX
KA-MT 25	K-MT25DESMIX	KA-MT 95	K-MT95DESMIX

Replacement filter elements for pre- and after filters (filter elements are included in the service-kit)

K-MT	PMC Order-No.		K-MT	PMC Order-No.	
Model	Filter size	Element grade VL, ZL, XL, A	Model	Filter size	Element grade VL, ZL, XL, A
KA-MT 10	GL9	CP3025_	KA-MT 45	GL12	CP4040_
KA-MT 15	GL9	CP3025_	KA-MT 60	GL13	CP4050_
KA-MT 20	GL9	CP3025_	KA-MT 75	GL13	CP4050_
KA-MT 25	GL11	CP3040_	KA-MT 95	GL14	CP4065_
KA-MT 35	GL11	CP3040_			

The underscore_ should be replaced by the element grade required. Example Filter GL9XL containing filter-element CP3025XL.

Loose accessories

Suitable for	PMC Order No.	Use	Suitable for	PMC Order No.	Use
KA-MT 10 - 95	VASDPD/K1-K95	Dew-point measuren.	KA-MT 10 - 20	VASVPB/K10-K20/25	Start-up device G1i
KA-MT 10 - 95	VASMBS420	Signal doppler 4-20 mA	KA-MT 25 - 45	VASVPB/K25-K45/40	Start-up device G1 1/2i
KA-MT 10 - 15	VASFS5/K10-K15	Fine filter silencer	KA-MT 60 - 75	VASVPB/K60-K75/50	Start-up device G2i
KA-MT 20 - 25	VASFS5/K20-K25	Fine filter silencer	KA-MT 95	VASVPB/K95/65	Start-up device G2 1/2i
KA-MT 35 - 60	VASFS5/K35-K60	Fine filter silencer	KA-MT 10 - 75	VASRGR/K10-K75	Regeneration gas recirculation
KA-MT 75 - 95	VASFS5/K75-K95	Fine filter silencer	KA-MT 95	VASRGR/K95	Regeneration gas recirculation
			KA-MT 10 - 95	VASNOZ/K1-K75	Nozzle-kit



KEA-MT 10-95 Series

GENERATION 1

From 04/2007 to 07/2011

For the maintenance of this product range, 12/36, 24 and 48 month service-kits are required, together with other components referenced below. Furthermore a 48 month maintenance interval requires an exchange of desiccant (see DESMIX). When the oil-control indicator shows that activated carbon replacement is required or at least after 12 months operation, this must be carried out. Independent of the level of discolouration in the indicator-tube (P02/ZR), the oil-control indicator must also be replaced.

12 and 36 month interval

Material required: Service-kit, filter elements, silencer
 Service-kit contents: Re-set module, pilot valves
 Options: Dew point sensor ZHM 100/450

KEA-MT	Material required - PMC Order-No.			Options - PMC Order-No.	
Model	Service-kit	Filter-element	Silencer	Others	
KEA-MT 10 - 25	KE-MT12A	See replacement filter elements on opposite page	SDD-25/AL	ZHM100/450	P02/ZR
KEA-MT 35 - 60			SDD-40/AL		
KEA-MT 75 - 95			SDD-50/AL		

24 and 48 month interval

Material required: Service-kit, silencer, filter-elements, DESPAC (see on opposite page)
 48-month interval: Also DESMIX packs (see on opposite page)
 Service-kit contents: Re-set module, wear part set for in- and outlet-valves, non-return-valves
 O-ring sets (internal/external) for solenoid valve block, pilot valves, solenoid coils 230V
 Options: Dew-point sensor ZHM100/450, Indicator-tube P02/ZR

KEA-MT	Material required - PMC Order-No.			Options - PMC Order-No.	
Model	Service-kit	Filter-element	Silencer	Others	
KEA-MT 10 - 25	KE-MT24A	See replacement filter elements on opposite page	SDD-25/AL	ZHM100/450	P02/ZR
KEA-MT 35 - 60	KE-MT24B		SDD-40/AL		
KEA-MT 75 - 95			SDD-50/AL		

KEA-MT 10-95 Series

GENERATION 1
From 04/2007 to 07/2011



DESPAC

12, 24, 36, 48 month interval

Content DESPAC: Activated carbon in 3 kg or 10 kg packs

PMC Order No.	KEA-MT 10	KEA-MT 15	KEA-MT 20	KEA-MT 25	KEA-MT 35	KEA-MT 45	KEA-MT 60	KEA-MT 75	KEA-MT 95
DESPAC3AK		1	2	1		3	3	1	
DESPAC10AK	1	1	1	2	3	3	5	6	8

DESMIX

48 month interval

DESMIX content: Molecular sieve in 1 kg, 4 kg, 15 kg or 140 kg packs

Model	PMC Order-No.	Model	PMC Order-No.
KEA-MT 10	K-MT10DESMIX	KEA-MT 35	K-MT35DESMIX
KEA-MT 15	K-MT15DESMIX	KEA-MT 45 - 60	K-MT60DESMIX
KEA-MT 20	K-MT20DESMIX	KEA-MT 75	K-MT75DESMIX
KEA-MT 25	K-MT25DESMIX	KEA-MT 95	K-MT95DESMIX

Replacement filter elements for pre- and after filters

KEA-MT	PMC Order-No.		KEA-MT	PMC Order-No.	
Model	Filter size	Element grade V, ZP, XP, A	Model	Filter size	Element grade V, ZP, XP, A
KEA-MT 10	G9	2010_	KEA-MT 45	G12	2030_
KEA-MT 15	G9	2010_	KEA-MT 60	G13	2050_
KEA-MT 20	G11	2020_	KEA-MT 75	G14	3050_
KEA-MT 25	G11	2020_	KEA-MT 95	G14	3050_
KEA-MT 35	G12	2030_			

The underscore_ should be replaced by the element grade required. Example Filter G9XP containing filter-element 2010XP.

Loose accessories

Suitable for	PMC Order No.	Use	Suitable for	PMC Order No.	Use
KEA-MT 10 - 95	VASDPDP/K1-K95	Dew-point measurement	KEA-MT 10 - 25	VASVPB/K10-K20/25	Start-up device G1i
KEA-MT 10 - 95	VASMBS420	Signal doppler 4-20 mA	KEA-MT 35 - 60	VASVPB/K25-K45/40	Start-up device G1 1/2i
KEA-MT 10 - 15	VASFS5/K10-K15	Fine filter silencer	KEA-MT 75 - 95	VASVPB/K60-K75/50	Start-up device G2i
KEA-MT 20 - 25	VASFS5/K20-K25	Fine filter silencer	KEA-MT 10 - 75	VASRGR/K10-K75	Regeneration gas recirculation
KEA-MT 35 - 60	VASFS5/K35-K60	Fine filter silencer	KEA-MT 95	VASRGR/K95	Regeneration gas recirculation
KEA-MT 75 - 95	VASFS5/K75-K95	Fine filter silencer	KEA-MT 10 - 95	VASNOZ/K1-K75	Nozzle-kit

KEA-MT 200-1400 Series



GENERATION 0

5/2003 to 4/2007

For the maintenance of this product range, 12/36, 24 and 48 month service-kits are required, together with other components referenced below. Furthermore a 48 month maintenance interval requires an exchange of desiccant (see DESMIX). When the oil-control indicator shows that activated carbon replacement is required or at least after 12 months operation, this must be carried out. Independent of the level of discolouration in the indicator-tube (P02/ZR), the oil-control indicator must also be replaced.

12 and 36 month interval

Material required: Service-kit, filter elements, silencer
 Service-kit contents: Re-set module, pilot valves
 Options: Dew point sensor ZHM 100/450, Indicator-tube P02/ZR

KEA-MT	Material required - PMC Order-No.			Options - PMC Order-No.	
Model	Service-kit	Filter-element	Silencer	Others	
KEA-MT 200 - 500	KEN-MT12A	See replacement filter elements on opposite page	SDD-25/AL	ZHM100/450	P02/ZR
KEA-MT 600 - 1150			SDD-40/AL		
KEA-MT 1400			SDD-50/AL		

24 and 48 month interval

Material required: Service-kit, silencer, filter elements
 48 month interval: Additional DESMIX (see on opposite page)
 Service-kit contents: Re-set module, wear part sets for in-/outlet valves and non-return valves, o-ring sets (in-/external) for solenoid valve block, pilot valves, solenoid coils 230V
 Options: Dew point sensor ZHM100/450, Indicator-tube P02/ZR

KEA-MT	Material required - PMC Order-No.			Options - PMC Order-No.	
Model	Service-kit	Filter-element	Silencer	Others	
KEA-MT 200 - 500	KEN-MT24A	See replacement filter elements on opposite page	SDD-25/AL	ZHM100/450	P02/ZR
KEA-MT 600 - 1150	KEN-MT24B		SDD-40/AL		
KEA-MT 1400			SDD-50/AL		

KEA-MT 200-1400 Series

GENERATION 0
5/2003 to 4/2007



DESPAC

12, 24, 36, 48 month interval

Content DESPAC: Activated carbon in 3 kg or 10 kg packs

PMC Order No.	KEA-MT 200	KEA-MT 300	KEA-MT 400	KEA-MT 500	KEA-MT 600	KEA-MT 800	KEA-MT 1150	KEA-MT 1400
DESPAC3AK	1	3	1	1	1	2	1	-
DESPAC10AK	1	1	2	2	3	4	6	8

DESMIX

48 month interval

DESMIX content: Molecular sieve in 1 kg, 4 kg, 15 kg or 140 kg packs

Model	PMC Order-No.	Model	PMC Order-No.
KEA-MT 200	KEN200DESMIX	KEA-MT 600	KEN600DESMIX
KEA-MT 300	KEN300DESMIX	KEA-MT 800	KEN800DESMIX
KEA-MT 400	KEN400DESMIX	KEA-MT 1150	KEN1150DESMIX
KEA-MT 500	KEN500DESMIX	KEA-MT 1400	KEN1400DESMIX

Replacement filter elements for pre- and after filters

KEA-MT	PMC Order-No.		KEA-MT	PMC Order-No.	
Model	Filter size	Element grade V, ZP, XP, A	Model	Filter size	Element grade V, ZP, XP, A
KEA-MT 200	G9	2010_	KEA-MT 600	G12	2030_
KEA-MT 300	G9	2010_	KEA-MT 800	G12	2030_
KEA-MT 400	G11	2020_	KEA-MT 1150	G13	2050_
KEA-MT 500	G11	2020_	KEA-MT 1400	G14	3050_

The underscore_ should be replaced by the element grade required. Example Filter G9XP containing filter-element 2010XP.

Loose accessories

Suitable for	PMC Order No.	Use	Suitable for	PMC Order No.	Use
KEA-MT 200 - 400	VASDPD/K1-K95	Dew-point measurement	KEA-MT200 - 500	VASVPB/K10-K2/25	Start-up device G1i
KEA-MT200 - 1400	VASMB5420	Signal doppler 4-20 mA	KEA-MT600 - 1150	VASVPB/K25-K45/40	Start-up device G1 1/2i
KEA-MT200 - 300	VASFS5/K10-K15	Fine filter silencer	KEA-MT1400	VASVPB/K60-K75/50	Start-up device G2i
KEA-MT400 - 500	VASFS5/K20-K25	Fine filter silencer	KEA-MT200 - 1150	VASRGR/K10-K75	Regeneration gas recirculation
KEA-MT600 - 1150	VASFS5/K35-K60	Fine filter silencer	KEA-MT1400	VASRGR/K95	Regeneration gas recirculation
KEA-MT1400	VASFS5/K75-K95	Fine filter silencer	KEA-MT200 - 1400	VASNOZ/K1-K75	Nozzle-kit

Breathing Air Systems BSP-MT

BSP-MT 1-8, BS(P)-MT 1-8, BS(P) 5-115 Series





BSP-MT 1-8 Series

GENERATION 3 (OIL-X filter)

From 01/2019 to the present day

For the maintenance of this product range, 12/36, 24 and 48 month service-kits are required, together with other components referenced below. Furthermore a 48 month maintenance interval requires an exchange of adsorbent (see DESPACs).

12 and 36 month interval

Material required: Service-kit, DESPACs see on opposite page
 Service-kit: Re-set module, silencer, filter-elements, perforated plate gaskets
 Options: Dew point sensor ZHM100/450

BSP-MT	Material required - PMC Order-No.			Options - PMC Order-No.	
Product Code	Service-kit			Others	
BSP-MT 1 - 4	SKK1-K4/BP3/12			ZHM100/450	
BSP-MT 6 - 7	SKK6-K7/BP3/12				
BSP-MT 8	SKK8/BP3/12				

24 month interval

Material required: Service-kit, DESPACs see on opposite page
 Service-kit contents: Re-set module, silencer, filter-elements, wear part sets for in-/outlet-valves
 Options: Dew point sensor ZHM100/450

BSP-MT	Material required - PMC Order-No.			Options - PMC Order-No.	
Product Code	Service-kit			Others	
BSP-MT 1 - 4	SKK1-K4/BP3/24			ZHM100/450	
BSP-MT 6 - 7	SKK6-K7/BP3/24				
BSP-MT 8	SKK8/BP3/24				

48 month interval

Material required: Service-kit, DESPACs see on opposite page
 Service-kit contents: Re-set module, silencer, filter-elements, perforated plates, perforated plate gaskets, solenoid coils 230V, wear part sets for in-/outlet-valves, non-return valves, 2 demister pads
 Options: Dew point sensor ZHM100/450

BSP-MT	Material required - PMC Order-No.			Options - PMC Order-No.	
Product Code	Service-kit			Others	
BSP-MT 1 - 4	SKK1-K4/BP3/48			ZHM100/450	
BSP-MT 6 - 7	SKK6-K7/BP3/48				
BSP-MT 8	SKK8/BP3/48				

Options : coils only for 50Hz (398H254061)

BSP-MT 1-8 Series

GENERATION 3 (OIL-X filter)
From 01/2019 to the present day



DESPACs

12, 24, 36, 48 month interval

Content DESPACs: Adsorbent packages

Vessel	PMC Order-No.	BSP-MT 1	BSP-MT 2	BSP-MT 3	BSP-MT 4	BSP-MT 6	BSP-MT 7	BSP-MT 8
Dryer (Vessel 1+2)	DESPAC2EF	1	2	3	4	7	9	11
Purifier (Vessel 3)	DESPAC3AK	1	1	1	1	1	2	2
	DESPAC1KTY	1	2	3	4	7	8	
	DESPAC4KTY							1

Replacement filter elements for pre- and after filters (filter elements are included in the service-kit)

BSP-MT	PMC Order-No.					
	UPstream Filter 1	Element grade	UPstream Filter 2	Element grade	Downstream Filter	Element grade
BSP-MT 1	AOP010AGFI	P010AO	AAP010AGFI	P010AA	AOP010AGMI	P010AO
BSP-MT 2	AOP010AGFI	P010AO	AAP010AGFI	P010AA	AOP010AGMI	P010AO
BSP-MT 3	AOP010AGFI	P010AO	AAP010AGFI	P010AA	AOP010AGMI	P010AO
BSP-MT 4	AOP010AGFI	P010AO	AAP010AGFI	P010AA	AOP010AGMI	P010AO
BSP-MT 6	AOP015AGFI	P015AO	AAP015AGFI	P015AA	AOP015AGMI	P015AO
BSP-MT 6	AOP015AGFI	P015AO	AAP015AGFI	P015AA	AOP015AGMI	P015AO
BSP-MT 8	AOP020DGFI	P020AO	AAP020DGFI	P020AA	AOP020DGFI	P020AO

The code spacing_ should contain the filter-element grade required. Example: Filter AOP010AFI containing filter-element P010AO.

Loose accessories

Suitable for	PMC Order-No.	Use	Suitable for	PMC Order-No.	Use
BSP-MT 1 - 8	VASRGR/K1-K8	Balance-line	BSP-MT 1 - 8	VASSDD08/15	Silencer
BSP-MT 1 - 8	VASDPDP/K1-K95	Dew point measurement	BSP-MT 1 - 4	VASFS3/K1-K4	Fine filter silencer
BSP-MT 1 - 8	VASMBS420	Signal Splitter 4-20 mA	BSP-MT 6 - 8	VASFS5/K6-K8	Fine filter silencer
BSP-MT 1 - 8	VASNOZ/K1-K95	Nozzle-kit			



BSP-MT 1-8 Series

GENERATION 2

From 07/2011 to 12/2018

For the maintenance of this product range, 12/36, 24 and 48 month service-kits are required, together with other components referenced below. Furthermore a 48 month maintenance interval requires an exchange of adsorbent (see DESPACs).

12 and 36 month interval

Material required: Service-kit, DESPACs see on opposite page
 Service-kit: Re-set module, silencer, filter-elements, perforated plate gaskets
 Options: Dew point sensor ZHM100/450

BSP-MT	Material required - PMC Order-No.			Options - PMC Order-No.	
Product Code	Service-kit			Others	
BSP-MT 1 - 4	SKK1-K4/BP2/12			ZHM100/450	
BSP-MT 6 - 7	SKK6-K7/BP2/12				
BSP-MT 8	SKK8/BP2/12				

24 month interval

Material required: Service-kit, DESPACs see on opposite page
 Service-kit contents: Re-set module, silencer, filter-elements, wear part sets for in-/outlet-valves
 Options: Dew point sensor ZHM100/450

BSP-MT	Material required - PMC Order-No.			Options - PMC Order-No.	
Product Code	Service-kit			Others	
BSP-MT 1 - 4	SKK1-K4/BP2/24			ZHM100/450	
BSP-MT 6 - 7	SKK6-K7/BP2/24				
BSP-MT 8	SKK8/BP2/24				

48 month interval

Material required: Service-kit, DESPACs see on opposite page
 Service-kit contents: Re-set module, silencer, filter-elements, perforated plates, perforated plate gaskets, solenoid coils 230V, wear part sets for in-/outlet-valves, non-return valves, 2 demister pads
 Options: Dew point sensor ZHM100/450

BSP-MT	Material required - PMC Order-No.			Options - PMC Order-No.	
Product Code	Service-kit			Others	
BSP-MT 1 - 4	SKK1-K4/BP2/48			ZHM100/450	
BSP-MT 6 - 7	SKK6-K7/BP2/48				
BSP-MT 8	SKK8/BP2/48				

BSP-MT 1-8 Series

GENERATION 2

From 07/2011 to 12/2018



DESPACs

12, 24, 36, 48 month interval

Content DESPACs: Adsorbent packages

Vessel	PMC Order-No.	BSP-MT 1	BSP-MT 2	BSP-MT 3	BSP-MT 4	BSP-MT 6	BSP-MT 7	BSP-MT 8
Dryer (Vessel 1+2)	DESPAC2EF	1	2	3	4	7	9	11
Purifier (Vessel 3)	DESPAC3AK	1	1	1	1	1	2	2
	DESPAC1KTY	1	2	3	4	7	8	
	DESPAC4KTY							1

Replacement filter elements for pre- and after filters (filter elements are included in the service-kit)

BSP-MT	PMC Order-No.		BSP-MT	PMC Order-No.	
Model	Filter housing size	Element grade VL, ZL, XL, A	Model	Filter housing size	Element grade VL, ZL, XL, A
BSP-MT 1	GL2	CP1008_	BSP-MT 6	GL5	CP2010_
BSP-MT 2	GL2	CP1008_	BSP-MT 7	GL5	CP2010_
BSP-MT 3	GL2	CP1008_	BSP-MT 8	GL7	CP2020_
BSP-MT 4	GL2	CP1008_			

The code spacing_ should contain the filter-element grade required. Example: Filter GL2XL containing filter-element CP1008XL.

Loose accessories

Suitable for	PMC Order-No.	Use	Suitable for	PMC Order-No.	Use
BSP-MT 1 - 8	VASRGR/K1-K8	Balance-line	BSP-MT 1 - 8	VASSDD08/15	Silencer
BSP-MT 1 - 8	VASDPDP/K1-K95	Dew point measurement	BSP-MT 1 - 4	VASFS3/K1-K4	Fine filter silencer
BSP-MT 1 - 8	VASMBS420	Signal Splitter 4-20 mA	BSP-MT 6 - 8	VASFS5/K6-K8	Fine filter silencer
BSP-MT 1 - 8	VASNOZ/K1-K95	Nozzle-kit			



BS(P)-MT 1-8 Series

GENERATION 1

From 05/2003 to 06/2011

For the maintenance of this product range, 12/36, 24 and 48 month service-kits are required, together with other components referenced below. Furthermore a 48 month maintenance interval requires an exchange of adsorbent (see DESPACs).

12 and 36 month interval

Material required: Service-kit, perforated plate gaskets (RKKMT und RKA), filter elements, silencer, DESPACs see opposite page

Service-kit contents: Re-set module
 Service-kit RKA: 2x perforated plate gaskets single profile
 Service-kit RKKMT: 2x perforated plate gaskets double profile
 Options: Dew point sensor ZHM 100/450

BS(P)-MT	Material required - PMC Order-No.			Options - PMC Order-No.	
Model	Service-kit		Filter-element	Silencer	Others
BS(P)-MT 1 - 4	K-MT12A	RKA1-A4	See replacement filter elements on opposite page	VASSDD08/15	ZHM100/450
		RKKMT1-K4			
RKA6-A8					
RKKMT6-K8					
BS(P)-MT 6 - 8					

24 month interval

Material required: Service-kit, perforated plate gaskets (RKKMT und RKA), filter elements, silencer, DESPACs see opposite page

Service-kit contents: Re-set module, wear part sets for in-/outlet-valves
 Service-kit RKA: 2x perforated plate gaskets single profile
 Service-kit RKKMT: 2x perforated plate gaskets double profile
 Options: Dew point sensor ZHM 100/450

BS(P)-MT	Material required - PMC Order-No.			Options - PMC Order-No.	
Model	Service-kit		Filter-element	Silencer	Others
BS(P)-MT 1 - 4	K-MT24A	RKA1-A4	See replacement filter elements on opposite page	VASSDD08/15	ZHM100/450
		RKKMT1-K4			
RKA6-A8					
RKKMT6-K8					
BS(P)-MT 6 - 8					

48 month interval

Material required: Service-kit, perforated plate gaskets (RKA) silencers, filter elements, DESPACs see opposite page

Service-kit contents: Re-set module, wear part set for in- and outlet-valves
 Service-kit contents RKA: Filter elements for after-filter, 2 x perforated plate gaskets with foamed seals
 Options: Dew-point sensor ZHM100/450, indicator-tube P02/ZR

BS(P)-MT	Material required - PMC Order-No.			Options - PMC Order-No.	
Model	Service-kit		Filter-element	Silencer	Others
BS(P)-MT 1 - 4	K-MT48A	RKA1-A4	See replacement filter elements on opposite page	VASSDD08/15	ZHM100/450
BS(P)-MT 6 - 8	K-MT48B	RKA6-A8			

BS(P)-MT 1-8 Series

GENERATION 1

From 05/2003 to 06/2011



DESPACs

12, 24, 36, 48 month interval

Content DESPACs: Adsorbent packages

Vessel	PMC Order-No.	BS(P)-MT 1	BS(P)-MT 2	BS(P)-MT 3	BS(P)-MT 4	BS(P)-MT 6	BS(P)-MT 7	BS(P)-MT 8
Dryer (Vessel 1+2)	DESPAC2EF	1	2	3	4	7	9	11
Purifier (Vessel 3)	DESPAC3AK	1	1	1	1	1	2	2
	DESPAC1KTY	1	2	3	4	7	8	
	DESPAC4KTY							1

Replacement filter elements for pre- and after filters

K-MT	PMC Order-No.		K-MT	PMC Order-No.	
Product code	Filter housing size	Element grade VL, ZL, XL, A	Product code	Filter housing size	Element grade VL, ZL, XL, A
BS(P)-MT 1	G2	1030_	BS(P)-MT 6	G5	1070_
BS(P)-MT 2	G2	1030_	BS(P)-MT 7	G5	1070_
BS(P)-MT 3	G2	1030_	BS(P)-MT 8	G7	1140_
BS(P)-MT 4	G2	1030_			

The code spacing_ should contain the filter-element grade required. Example: Filter G2XP containing filter element 1030XP

BS-MT: an XP-grade pre-filter element and a V-grade after-filter element are standard.

BSP-MT: an ZP-grade pre-filter element and a XP-grade element as well as the V-grade after-filter element are standard.

Loose accessories

Suitable for	PMC Order-No.	Use	Suitable for	PMC Order-No.	Use
BS(P)-MT 1 - 8	VASRGR/K1-K8	Balance-line	BS(P)-MT 1 - 8	VASSDD08/15	Silencer
BS(P)-MT 1 - 8	VASPD/P/K1-K95	Dew point measurement	BS(P)-MT 1 - 4	VASFS3/K1-K4	Fine filter silencer
BS(P)-MT 1 - 8	VASMBS420	Signal Splitter 4-20 mA	BS(P)-MT 6 - 8	VASFS5/K6-K8	Fine filter silencer
BS(P)-MT 1 - 8	VASNOZ/K1-K95	Nozzle-kit			



BS(P) 5-115 Series

GENERATION 0

Up to mid. 2003

Generation 0 dryers should be updated once to the latest technical specification using the following retrofit kits

For the maintenance of the updated series, 12/36, 24 and 48 month service-kits are required, together with other components referenced below. Furthermore a 48 month maintenance interval requires an exchange of adsorbent (see DESPACs).

Update-kit

Suitable for	PMC Order-No.	Replaceable contents
BS(P) 5 - 35	UKKM5-35	Solenoid valve plate incl. seals + cable + socket-coupling
BS(P) 5 - 35	UKKM5-35/RV	Non-return valve plate incl. seals
BS(P) 75 - 115	UKKM75-115	Solenoid valve plate incl. seals + cable + socket-coupling
BS(P) 75 - 115	UKKM75-115/RV	Non-return valve plate incl. seals

Update-kit Multitronic

Suitable for	PMC Order-No.	Replaceable contents
BS(P) 5 - 115	UKMT-230-ZHM	Multitronic + cable + ZHM100 + measuring chamber
BS(P) 5 - 115	UKMT-230	Multitronic + cable

After the conversion of the current control Multitronic every 12 month is the following service kit required

BS(P) 5 - 115	K-MT12A	Reset-modul
---------------	---------	-------------

12, 24 and 36 month interval

Material required: Service-kit, silencer, perforated plate gaskets, filter-elements, DESPACs see on opposite page
 Service-kit contents: wear part sets for in-/outlet-valves
 AKMKIT contents: 2x perforated plate gaskets single profile
 Options: Dew point sensor)

BS(P)	Material required - PMC Order-No.				Options - PMC Order-No.	
	Product Code	Service-kit		Filter-element	Silencer	Others
BS(P) 5 - 35	KM24A-UG	3 X	RKA1-A4	See replacement filter elements on opposite page	VASSDD08/15	ZHM100/450*
BS(P) 75 - 115		3 X	AKMKIT2			

* Dew-point sensor can vary in type: Please provide the construction number of the dryer when making an enquiry.

BS(P) 5-115 Series

GENERATION 0
Up to mid. 2003



48 month interval

Material required: Service-kit, perforated plate gaskets, filter elements, silencer, DESPACs see below
 Service-kit Contents: 4 x perforated plate gaskets single profile, solenoid coils 230V, wear part sets for in-/outlet-valves, re-set module, non-return valves
 AKMKIT Contents: 2 x perforated plate gaskets single profile
 Options: Dew point sensor

BS(P)	Material required - PMC Order-No.				Options	
Model	Service-kit			Filter-element	Silencer	Others
BS(P) 5 - 35	KM48A-UG	1x	RKA1-A4	See replacement filter elements on opposite page	VASSDD08/15	ZHM100/450*
BS(P) 75 - 115	KM48B-UG	1x	AKMKIT2			

* Dew-point sensor can vary in type: Please provide the construction number of the dryer when making an enquiry.

DESPACs

12, 24, 36, 48 month interval

Content DESPACs: Adsorbent packages

Vessel	PMC Order-No.	BS(P) 5	BS(P) 10	BS(P) 25	BS(P) 35	BS(P) 75	BS(P) 95	BS(P) 115
Dryer (Vessel 1+2)	DESPAC2EF	1	2	3	4	1		1
	DESPAC6EF					2	3	
	DESPAC20EF							1
Purifier (Vessel 3)	DESPAC3AK	1	1	1	1	1	2	2
	DESPAC1KTY	1	2	3	4	7	9	1
	DESPAC4KTY							1

Replacement filter elements for pre- and after filters

BS(P)	PMC Order-No.		BS(P)	PMC Order-No.	
Model	Filter housing size	Element grade VL, ZL, XL, A	Model	Filter housing size	Element grade VL, ZL, XL, A
BS(P) 5	G2	1030_	BS(P) 75	G5	1070_
BS(P) 10	G2	1030_	BS(P) 95	G5	1070_
BS(P) 25	G2	1030_	BS(P) 115	G7	1140_
BS(P) 35	G2	1030_			

The code spacing_ should contain the filter-element grade required. Example: Filter G2XP containing filter element 1030XP.

BS: an XP-grade pre-filter element and a ZP-grade after-filter element are standard.

BSP: an ZP-grade pre-filter element and a XP-grade element as well as the ZP-grade after-filter element are already included in the service-kit as standard.

Breathing Air Systems BSP-MT

BSP-MT 10-95, BSP-MT 10-95,
BS(P)-MT 10-95, BS(P)-MT 200-1400,
BS(P) 200-1400 Series





BSP-MT 10-95 Series

GENERATION 3 (OIL-X filter)

From 01/2019 to the present day

Service Kits for 12/36, 24/48 months are required for servicing this series, along with other components as stated. In addition, it is necessary to replace the adsorbent (see DESPACs) every 12 months.

12 and 36 month interval

Material required: Service-kit, DESPACs see on opposite page
 Service-kit contents: Re-set module, silencers, filter-elements, pilot valves
 Options: Dew-point sensor ZHM100/450

BSP-MT	Material required - PMC Order-No.		Options - PMC Order-No.	
Model	Service-kit	Mains voltage	Others	
BSP-MT 10 - 20	SKK10-K20/BP3/12	115V, 230V	ZHM100/450	
BSP-MT 25	SKK25/BP3/12	115V, 230V		
BSP-MT 35	SKK35/BP3/12	115V, 230V		
BSP-MT 45	SKK45/BP3/12	115V, 230V		
BSP-MT 60 - 75	SKK60-K75/BP3/12	115V, 230V		
BSP-MT 95	SKK95/BP3/12	115V, 230V		

24 and 48 month interval

Materials Required: Service Kit,
 Service-kit contents: Re-set module, silencer, filter elements, wear part set for in- and outlet-valves, non-return-valves, solenoid coils 230V, O-ring sets (internal/external) for solenoid valve block
 Options: Dew-point sensor ZHM100/450

BSP-MT	Material required - PMC Order-No.		Options - PMC Order-No.	
Model	Service-kit	Mains voltage	Others	
BSP-MT 10 - 20	SKK10-K20/BP3/24/115	115V	ZHM100/450	
	SKK10-K20/BP3/24	230V		
BSP-MT 25	SKK25/BP3/24/115	115V		
	SKK25/BP3/24	230V		
BSP-MT 35	SKK35/BP3/24/115	115V		
	SKK35/BP3/24	230V		
BSP-MT 45	SKK45/BP3/24/115	115V		
	SKK45/BP3/24	230V		
BSP-MT 60 - 75	SKK60-K75/BP3/24/115	115V		
	SKK60-K75/BP3/24	230V		
BSP-MT 95	SKK95/BP3/24/115	115V		
	SKK95/BP3/24	230V		

Options : coils only for 50Hz (398H254061)

BSP-MT 10-95 Series

GENERATION 3 (OIL-X filter)
From 01/2019 to the present day



DESPACs

12, 24, 36, 48 month interval

Content DESPACs: Adsorbent packages

Vessel	PMC Order-No.	BSP-MT 10	BSP-MT 15	BSP-MT 20	BSP-MT 25	BSP-MT 35	BSP-MT 45	BSP-MT 60	BSP-MT 75	BSP-MT 95
Dryer (Vessel 1+2)	DESPAC6EF	2		1						
	DESPAC20EF	1	2	2	3	4	5	7	9	12
Cleaner (Vessel 3)	DESPAC3AK	2	3		1	2		2		
	DESPAC10AK			1	1	1	2	2	4	5
	DESPAC4KTY	2	2	3	4	6	7	10	14	18
0.4 kg	DESPAC1KTY	1	7	4	5	-	5	2	2	-

Replacement filter elements for pre- and after filters (filter elements are included in the service-kit)

BSP-MT	PMC Order-No.					
	UPstream Filter 1	Element grade	UPstream Filter 2	Element grade	Downstream Filter	Element grade
BSP-MT 10	AOP025EGFI	P025AO	AAP025EGFI	P025AA	AOP025EGMI	P025AO
BSP-MT 15	AOP025EGFI	P025AO	AAP025EGFI	P025AA	AOP025EGMI	P025AO
BSP-MT 20	AOP025EGFI	P025AO	AAP025EGFI	P025AA	AOP025EGMI	P025AO
BSP-MT 25	AOP030GGFI	P030AO	AAP030GGFI	P030AA	AOP030GGMI	P030AO
BSP-MT 35	AOP030GGFI	P030AO	AAP030GGFI	P030AA	AOP030GGMI	P030AO
BSP-MT 45	AOP035GGFX	P035AO	AAP035GGFX	P035AA	AOP035GGMX	P035AO
BSP-MT 60	AOP040HGFX	P040AO	AAP040HGFX	P040AA	AOP040HGMX	P040AO
BSP-MT 75	AOP040HGFX	P040AO	AAP040HGFX	P040AA	AOP040HGMX	P040AO
BSP-MT 95	AOP045IGFX	P045AO	AAP045IGFX	P045AA	AOP045IGMX	P045AO

The underscore_ should be replaced by the element grade required. Example Filter AOP035GGFX containing filter-element P035AO.

Loose accessories

Suitable for	PMC Order No.	Use	Suitable for	PMC Order No.	Use
BSP-MT 10 - 95	VASDPDP/K1-K95	Dewpoint Measurement	BSP-MT 10 - 20	VASVPB/K10-K20/25	Start-up device G1i
BSP-MT 10 - 95	VASMBMS420	Signal doppler 4-20 mA	BSP-MT 25 - 45	VASVPB/K25-K45/40	Start-up device G1 1/2i
BSP-MT 10 - 15	VASFSS/K10-K15	Fine filter silencer	BSP-MT 60 - 75	VASVPB/K60-K75/50	Start-up device G2i
BSP-MT 20 - 25	VASFSS/K20-K25	Fine filter silencer	BSP-MT 10 - 75	VASRGR/K10-K75	Regeneration gas recirculation
BSP-MT 35 - 60	VASFSS/K35-K60	Fine filter silencer	BSP-MT 95	VASRGR/K95	Regeneration gas recirculation
BSP-MT 75 - 95	VASFSS/K75-K95	Fine filter silencer			

BSP-MT 10-95 Series



GENERATION 2

From 07/2011 to 12/2018

Service Kits for 12/36, 24/48 months are required for servicing this series, along with other components as stated. In addition, it is necessary to replace the adsorbent (see DESPACs) every 12 months.

12 and 36 month interval

Material required: Service-kit, DESPACs see on opposite page
 Service-kit contents: Re-set module, silencers, filter-elements, pilot valves
 Options: Dew-point sensor ZHM100/450

BSP-MT	Material required - PMC Order-No.		Options - PMC Order-No.	
Model	Service-kit		Others	
BSP-MT 10 - 20	SKK10-K20/BP2/12		ZHM100/450	
BSP-MT 25	SKK25/BP2/12			
BSP-MT 35	SKK35/BP2/12			
BSP-MT 45	SKK45/BP2/12			
BSP-MT 60 - 75	SKK60-K75/BP2/12			
BSP-MT 95	SKK95/BP2/12			

24 and 48 month interval

Materials Required: Service Kit,
 Service-kit contents: Re-set module, silencer, filter elements, wear part set for in- and outlet-valves, non-return-valves, solenoid coils 230V, O-ring sets (internal/external) for solenoid valve block
 Options: Dew-point sensor ZHM100/450

BSP-MT	Material required - PMC Order-No.		Options - PMC Order-No.	
Model	Service-kit		Others	
BSP-MT 10 - 20	SKK10-K20/BP2/24		ZHM100/450	
BSP-MT 25	SKK25/BP2/24			
BSP-MT 35	SKK35/BP2/24			
BSP-MT 45	SKK45/BP2/24			
BSP-MT 60 - 75	SKK60-K75/BP2/24			
BSP-MT 95	SKK95/BP2/24			

BSP-MT 10-95 Series

GENERATION 2
From 07/2011 to 12/2018



DESPACs

12, 24, 36, 48 month interval

Content DESPACs: Adsorbent packages

Vessel	PMC Order-No.	BSP-MT 10	BSP-MT 15	BSP-MT 20	BSP-MT 25	BSP-MT 35	BSP-MT 45	BSP-MT 60	BSP-MT 75	BSP-MT 95
Dryer (Vessel 1+2)	DESPAC6EF	2		1						
	DESPAC20EF	1	2	2	3	4	5	7	9	12
Cleaner (Vessel 3)	DESPAC3AK	2	3		1	2		2		
	DESPAC10AK			1	1	1	2	2	4	5
	DESPAC4KTY	2	2	3	4	6	7	10	14	18
0.4 kg	DESPAC1KTY	1	7	4	5	-	5	2	2	-

Replacement filter elements for pre- and after filters (filter elements are included in the service-kit)

BSP-MT	PMC Order-No.		BSP-MT	PMC Order-No.	
Model	Filter size	Element grade VL, ZL, XL, A	Model	Filter size	Element grade VL, ZL, XL, A
BSP-MT 10	GL9	CP3025_	BSP-MT 45	GL12	CP4040_
BSP-MT 15	GL9	CP3025_	BSP-MT 60	GL13	CP4050_
BSP-MT 20	GL9	CP3025_	BSP-MT 75	GL13	CP4050_
BSP-MT 25	GL11	CP3040_	BSP-MT 95	GL14	CP4065_
BSP-MT 35	GL11	CP3040_			

The underscore_ should be replaced by the element grade required. Example Filter GL9XL containing filter-element CP3025XL.

Loose accessories

Suitable for	PMC Order No.	Use	Suitable for	PMC Order No.	Use
BSP-MT 10 - 95	VASDPDP/K1-K95	Dewpoint Measurement	BSP-MT 10 - 20	VASVPB/K10-K20/25	Start-up device G1i
BSP-MT 10 - 95	VASMBS420	Signal doppler 4-20 mA	BSP-MT 25 - 45	VASVPB/K25-K45/40	Start-up device G1 1/2i
BSP-MT 10 - 15	VASFS5/K10-K15	Fine filter silencer	BSP-MT 60 - 75	VASVPB/K60-K75/50	Start-up device G2i
BSP-MT 20 - 25	VASFS5/K20-K25	Fine filter silencer	BSP-MT 10 - 75	VASRGR/K10-K75	Regeneration gas recirculation
BSP-MT 35 - 60	VASFS5/K35-K60	Fine filter silencer	BSP-MT 95	VASRGR/K95	Regeneration gas recirculation
BSP-MT 75 - 95	VASFS5/K75-K95	Fine filter silencer			



BS(P)-MT 10-95 Series

GENERATION 1

from 04/2007 to 07/2011

Service Kits for 12/36, 24, and 48 months are required for servicing this series, along with other components as stated. For air systems, it is recommended that the desiccant be replaced annually and the cleaning material for the 3rd stage be replaced every six months.

12 and 36 month interval

Material required: Service-kit, DESPACs see on opposite page
 Service-kit contents: Re-set module, silencers, filter-elements, pilot valves
 Options: Dew-point sensor ZHM100/450

BS(P)-MT	Material required - PMC Order-No.			Options - PMC Order-No.	
Model	Service-kit	Filter-element	Silencer	Others	
BS(P)-MT 10 - 25	KE-MT12A	See replacement filter elements on opposite page	SDD-25/AL	ZHM100/450	
BS(P)-MT 35 - 60			SDD-40/AL		
BS(P)-MT 75 - 95			SDD-50/AL		

24 and 48 month interval

Material required: Service-kit, silencer, filter-elements, DESPAC (see on opposite page)
 Service-kit contents: Re-set module, wear part set for in- and outlet-valves, non-return-valves, O-ring sets (internal/external) MV block, pilot valves, solenoid coils 230V
 Options: Dew-point sensor ZHM100/450

BS(P)-MT	Material required - PMC Order-No.			Options - PMC Order-No.	
Model	Service-kit	Filter-element	Silencer	Others	
BS(P)-MT 10 - 25	KE-MT24A	See replacement filter elements on opposite page	SDD-25/AL	ZHM100/450	
BS(P)-MT 35 - 60	KE-MT24B		SDD-40/AL		
BS(P)-MT 75 - 95			SDD-50/AL		

BS(P)-MT 10-95 Series

GENERATION 1

from 04/2007 to 07/2011



DESPACs

12, 24, 36, 48 month interval

Content DESPACs: Adsorbent packages

Vessel	PMC Order-No.	BS(P)-MT 10	BS(P)-MT 15	BS(P)-MT 20	BS(P)-MT 25	BS(P)-MT 35	BS(P)-MT 45	BS(P)-MT 60	BS(P)-MT 75	BS(P)-MT 95
Dryer (Vessel 1+2)	DESPAC6EF	2		1						
	DESPAC20EF	1	2	2	3	4	5	7	9	12
Cleaner (Vessel 3)	DESPAC3AK	2	3		1	2		2		
	DESPAC10AK			1	1	1	2	2	4	5
	DESPAC4KTY	2	2	3	4	6	7	10	14	18

Replacement filter elements for pre- and after filters

BS(P)-MT	PMC Order-No.		BS(P)-MT	PMC Order-No.	
Model	Filter size	Element grade V, ZP, XP, A	Model	Filter size	Element grade V, ZP, XP, A
BS(P)-MT 10	G9	2010_	BS(P)-MT 45	G12	2030_
BS(P)-MT 15	G9	2010_	BS(P)-MT 60	G13	2050_
BS(P)-MT 20	G11	2020_	BS(P)-MT 75	G14	3050_
BS(P)-MT 25	G11	2020_	BS(P)-MT 95	G14	3050_
BS(P)-MT 35	G12	2030_			

The underscore _ must be replaced by the element type. Example: Filter G9XP with filter element 2010XP

For the BS-MT series, the XP type prefilter element and the V type postfilter element are used as standard. For the BSP-MT series, the ZP and XP type prefilter and the ZL type postfilter element is used.

Loose accessories

Suitable for	PMC Order No.	Use	Suitable for	PMC Order No.	Use
BS(P)-MT 10 - 95	VASDPD/K1-K95	Dewpoint Measurement	BS(P)-MT 10 - 25	VASVPB/K10-K20/25	Start-up device G1i
BS(P)-MT 10 - 95	VASMBS420	Signal doppler 4-20 mA	BS(P)-MT 35 - 60	VASVPB/K25-K45/40	Start-up device G1 1/2i
BS(P)-MT 10 - 15	VASF55/K10-K15	Fine filter silencer	BS(P)-MT 75 - 95	VASVPB/K60-K75/50	Start-up device G2i
BS(P)-MT 20 - 25	VASF55/K20-K25	Fine filter silencer	BS(P)-MT 10 - 75	VASRGR/K10-K75	Regeneration gas recirculation
BS(P)-MT 35 - 60	VASF55/K35-K60	Fine filter silencer	BS(P)-MT 95	VASRGR/K 95	Regeneration gas recirculation
BS(P)-MT 75 - 95	VASF55/K75-K95	Fine filter silencer			



BS(P)-MT 200-1400 Series

GENERATION 0

from 04/2005 to 04/2007

Service Kits for 12/36, 24, and 48 months are required for servicing this series, along with other components as stated. For air systems, it is recommended that the desiccant be replaced annually and the cleaning material for the 3rd stage be replaced every six months.

12 and 36 month interval

Material required: Service-kit, DESPACs see on opposite page
 Service-kit contents: Re-set module, silencers, filter-elements, pilot valves
 Options: Dew-point sensor ZHM100/450

BS(P)-MT	Material required - PMC Order-No.			Options - PMC Order-No.	
Model	Service-kit	Filter-element	Silencer	Others	
BS(P)-MT 200 - 500	KE-MT12A	See replacement filter elements on opposite page	SDD-25/AL	ZHM100/450	
BS(P)-MT 600 - 1150			SDD-40/AL		
BS(P)-MT 1400			SDD-50/AL		

24 and 48 month interval

Material required: Service-kit, silencer, filter-elements, DESPAC (see on opposite page)
 Service-kit contents: Re-set module, wear part set for in- and outlet-valves, non-return-valves, O-ring sets (internal/external) MV block, pilot valves, solenoid coils 230V
 Options: Dew-point sensor ZHM100/450

BS(P)-MT	Material required - PMC Order-No.			Options - PMC Order-No.	
Model	Service-kit	Filter-element	Silencer	Others	
BS(P)-MT 200 - 500	KE-MT24A	See replacement filter elements on opposite page	SDD-25/AL	ZHM100/450	
BS(P)-MT 600 - 1150	KE-MT24B		SDD-40/AL		
BS(P)-MT 1400			SDD-50/AL		

BS(P)-MT 200-1400 Series

GENERATION 0
from 04/2005 to 04/2007



DESPACs

12, 24, 36, 48 month interval

Content DESPACs: Adsorbent packages

Vessel	PMC Order-No.	BS(P)-MT 200	BS(P)-MT 300	BS(P)-MT 400	BS(P)-MT 500	BS(P)-MT 600	BS(P)-MT 800	BS(P)-MT 1150	BS(P)-MT 1400
Dryer (Vessel 1+2)	DESPAC6EF	3	2	1	2				
	DESPAC20EF	1	2	3	4	5	8	10	12
Cleaner (Vessel 3)	DESPAC3AK	3		2		1	2	1	1
	DESPAC10AK		1	1	2	2	3	4	5
	DESPAC1KTY	7	4	1	4			4	1
	DESPAC4KTY	1	2	3	4	5	8	9	12

Replacement filter elements for pre- and after filters

BS(P)-MT	PMC Order-No.		BS(P)-MT	PMC Order-No.	
Model	Filter size	Element grade V, ZP, XP, A	Model	Filter size	Element grade V, ZP, XP, A
BS(P)-MT 200	G9	2010_	BS(P)-MT 600	G12	2030_
BS(P)-MT 300	G9	2010_	BS(P)-MT 800	G12	2030_
BS(P)-MT 400	G11	2020_	BS(P)-MT 1150	G13	2050_
BS(P)-MT 500	G11	2020_	BS(P)-MT 1400	G14	3050_

The underscore _ must be replaced by the element type. Example: Filter G9XP with filter element 2010XP

For the BS-MT series, the XP type prefilter element and the V type postfilter element are used as standard. For the BSP-MT series, the ZP and XP type prefilter and ZL type postfilter elements are used.

Loose accessories

Suitable for	PMC Order No.	Use	Suitable for	PMC Order No.	Use
BS(P)-MT 200 - 400	VASDPDP/K1-K95	Dewpoint Measurement	BS(P)-MT 200 - 500	VASVPB/K10-K2/25	Start-up device G1i
BS(P)-MT 200 - 1400	VASMBS420	Signal doppler 4-20 mA	BS(P)-MT 600 - 1150	VASVPB/K25-K45/40	Start-up device G1 1/2i
BS(P)-MT 200 - 300	VASF5/K10-K15	Fine filter silencer	BS(P)-MT 1400	VASVPB/K60-K75/50	Start-up device G2i
BS(P)-MT 400 - 500	VASF5/K20-K25	Fine filter silencer	BS(P)-MT 200 - 1150	VASRGR/K10-K75	Regeneration gas recirculation
BS(P)-MT 600 - 1150	VASF5/K35-K60	Fine filter silencer	BS(P)-MT 1400	VASRGR/K95	Regeneration gas recirculation
BS(P)-MT 1400	VASF5/K75-K95	Fine filter silencer			



BS(P) 200-1400 Series

GENERATION -1

5/2002 to 4/2005

Service Kits for 12/36, 24, and 48 months are required for servicing this series, along with other components as stated. For air systems, it is recommended that the desiccant be replaced annually and the cleaning material for the 3rd stage be replaced every six months.

Update Kit Multitronic

suitable for	PMC Order No.	Function
BS(P) 200 to BS(P) 1400	UKMT-230-ZHM	Multitronic + ZHM100 + Cable + Measurement chamber
BS(P) 200 to BS(P) 1400	UKMT-230	Multitronic + Cable

After converting to the current Multitronic controls, you need the generation 0 Service Kit

12 and 36 month interval

Material required: Service-kit, DESPACs see on opposite page
 Service-kit contents: Re-set module, silencers, filter-elements, pilot valves
 Options: Dew-point sensor ZHM100/450

BS(P)	Material required - PMC Order-No.			Options - PMC Order-No.	
Model	Service-kit	Filter-element	Silencer	Others	
BS(P) 200-500	BS12A	See replacement filter elements on opposite page	SDD-25/AL	ZHM100/450	
BS(P) 600-800			SDD-40/AL		
BS(P) 1150-1400			SDD-50/AL		

24 and 48 month interval

Material required: Service-kit, silencer, filter-elements, DESPAC (see on opposite page)
 Service-kit contents: Re-set module, wear part set for in- and outlet-valves, non-return-valves, O-ring sets (internal/external) MV block, pilot valves, solenoid coils 230V
 Options: Dew-point sensor ZHM100/450

BS(P)	Material required - PMC Order-No.			Options - PMC Order-No.	
Model	Service-kit	Filter-element	Silencer	Others	
BS(P) 200-500	BS24A	See replacement filter elements on opposite page	SDD-25/AL	ZHM100/450	
BS(P) 600-1150	BS24B		SDD-40/AL		
BS(P) 1400			SDD-50/AL		

BS(P) 200-1400 Series

GENERATION -1
5/2002 to 4/2005



DESPACs

12, 24, 36, 48 month interval

Content DESPACs: Adsorbent packages

Vessel	PMC Order-No.	BS(P) 200	BS(P) 300	BS(P) 400	BS(P) 500	BS(P) 600	BS(P) 800	BS(P) 1150	BS(P) 1400
Dryer (Vessel 1+2)	DESPAC6EF	3	2	1	2				
	DESPAC20EF	1	2	3	4	5	8	10	12
Cleaner (Vessel 3)	DESPAC3AK	3		2		1	2	1	1
	DESPAC10AK		1	1	2	2	3	4	5
	DESPAC1KTY	7	4	1	4			4	1
	DESPAC4KTY	1	2	3	4	5	8	9	12

Replacement filter elements for pre- and after filters

BS(P)	PMC Order-No.		BS(P)	PMC Order-No.	
Model	Filter size	Element grade V, ZP, XP, A	Model	Filter size	Element grade V, ZP, XP, A
BS(P) 200	G9	2010_	BS(P) 600	G12	2030_
BS(P) 300	G9	2010_	BS(P) 800	G12	2030_
BS(P) 400	G11	2020_	BS(P) 1150	G13	2050_
BS(P) 500	G11	2020_	BS(P) 1400	G14	3050_

The underscore _ must be replaced by the element type. Example: Filter G9XP with filter element 2010XP

For the BS-MT series, the XP type prefilter element and the V type postfilter element are used as standard. For the BSP-MT series, the ZP and XP type prefilter and ZL type postfilter elements are used.

Loose accessories

Suitable for	PMC Order No.	Use	Suitable for	PMC Order No.	Use
BS(P) 200 - 400	VASPDP/K1-K95	Dewpoint Measurement	BS(P) 200 - 500	VASVPB/K10-K2/25	Start-up device G1i
BS(P) 200 - 1400	VASMBS420	Signal doppler 4-20 mA	BS(P) 600 - 1150	VASVPB/K25-K45/40	Start-up device G1 1/2i
BS(P) 200 - 300	VASF5/K10-K15	Fine filter silencer	BS(P) 1400	VASVPB/K60-K75/50	Start-up device G2i
BS(P) 400 - 500	VASF5/K20-K25	Fine filter silencer	BS(P) 200 - 1150	VASRGR/K10-K75	Regeneration gas recirculation
BS(P) 600 - 1150	VASF5/K35-K60	Fine filter silencer	BS(P) 1400	VASRGR/K95	Regeneration gas recirculation
BS(P) 1400	VASF5/K75-K95	Fine filter silencer			

HDK Series

HDK 18/25-550/50

HDK-MT 100 & 350





HDK 18/25 & 550/50 Series

GENERATION D0

from 2010 to the present day

For the maintenance of this product range, 12 month service-kits are required, together with other components referenced below. Furthermore a 48 month maintenance interval requires a DESPAC-package (Adsorption material package) containing all filling-materials for the dryer model in question.

12 Month interval

Material required:

Dongle, Silencer, Pre- and after filterelements, dewpointsensor ZHM100/450

HDK		Material required – PMC Order No.				Options – PMC Order No.	
Product code	Barg	Service kit	Filter housing	Element grade	Silencer	Dewpoint sensor	
HDK 18 /...	25 50	K-MT12A	G3	1050 XP / V	2 x SDD-15/600/AL	ZHM100/450	
HDK 40 /...	25 50		G3	1050 XP / V			
HDK 80 /...	25 50		G5	1070 XP / V			
HDK 120 /...	25 50		G7	1140 XP / V			
HDK 160 /...	25 50		G9	2010 XP / V			
HDK 210 /...	25 50		G9	2010 XP / V			
HDK 360 /...	25 50		G11	2020 XP / V			
HDK 550 /...	25 50		G12	2030 XP / V			

DESPACs

48 month interval

Content DESPACs: Molecular sieve in 1 kg, 4 kg or 15 kg packs

PMC Order-No.	HDK 18/...	HDK 40/...	HDK 80/...	HDK 120/...	HDK 160/...	HDK 210/...	HDK 360/...	HDK 550/...
DESPAC1MS		3	2	2	2		1	1
DESPAC4MS	1	1		1		1		2
DESPAC15MS			1	1	2	2	5	7

Accessories, separate or installed at factory

PMC Order No.	Description
TRAP2/100-G230/P	Time controlled solenoid valve G1/4i, PN100, 2-55 °C, 115 VAC, IP65
HZD80/420RG	calibrated analogue differential pressure gauge PN420
HZDE80/420RG	calibrated analogue differential pressure gauge PN420 with Reed contact (IP54)
VASMBS420	Contact 4-20 mA for analogue output of dewpoint signal
ET-VENT-HALTE-G20-3	Start-up device DN12,7

HDK 18/25 & 550/50 Series

GENERATION D0
from 2010 to the present day



HDK	Material required – PMC Order No.			HDK	Material required – PMC Order No.		
	N°	PMC Order No.	Scope of delivery		N°	PMC Order No.	Scope of delivery
H18	2 x	RK-SCD-G32X90/VA-HDK	Dust sieve (2x)	H160	2 x	RK-SCD-G32X90/VA-HDK	Dust sieve (2x)
	5 x	ET-321HS3330B-2995-483/S1	Solenoid valve		5 x	ET-321HS3330C-2995-483/S1	Solenoid valve
	2 x	RHD15L0.2BCF	no return valve		2 x	RHD22L0.2BCF	no return valve
	3 x	ET-MANO.063SR711C	Pressure gauge		3 x	ET-MANO.063SR711C	Pressure gauge
	1 x	ET-DRM.G08-AIRCOM-5	Pressure reducer		1 x	ET-DRM.G08-AIRCOM-5	Pressure reducer
	5 x	RHD12L0.2BCF	no return valve		5 x	RHD12L0.2BCF	no return valve
H40	2 x	RK-SCD-G32X90/VA-HDK	Dust sieve (2x)	H210	2 x	RK-SCD-G32X90/VA-HDK	Dust sieve (2x)
	5 x	ET-321HS3330B-2995-483/S1	Solenoid valve		5 x	ET-321HS3330C-2995-483/S1	Solenoid valve
	2 x	RHD15L0.2BCF	no return valve		2 x	RHD22L0.2BCF	no return valve
	3 x	ET-MANO.063SR711C	Pressure gauge		3 x	ET-MANO.063SR711C	Pressure gauge
	1 x	ET-DRM.G08-AIRCOM-5	Pressure reducer		1 x	ET-DRM.G08-AIRCOM-5	Pressure reducer
	5 x	RHD12L0.2BCF	no return valve		5 x	RHD12L0.2BCF	no return valve
H80	2 x	RK-SCD-G32X90/VA-HDK	Dust sieve (2x)	H360	2 x	RK-SCD-G32X90/VA-HDK	Dust sieve (2x)
	5 x	ET-321HS3330B-2995-483/S1	Solenoid valve		3 x	ET-321HS3330B-2995-483/S1	Solenoid valve
	2 x	RHD15L0.2BCF	no return valve		2 x	ET-321HS3330C-2995-483/S1	Solenoid valve
	3 x	ET-MANO.063SR711C	Pressure gauge		2 x	RHD28L0.2BCF	no return valve
	1 x	ET-DRM.G08-AIRCOM-5	Pressure reducer		3 x	ET-MANO.063SR711C	Pressure gauge
	5 x	RHD12L0.2BCF	no return valve		1 x	ET-DRM.G08-AIRCOM-5	Pressure reducer
H120	2 x	RK-SCD-G32X90/VA-HDK	Dust sieve (2x)	H550	5 x	RHD12L0.2BCF	no return valve
	5 x	ET-321HS3330B-2995-483/S1	Solenoid valve		2 x	RK-SCD-G32X90/VA-HDK	Dust sieve (2x)
	2 x	RHD15L0.2BCF	no return valve		3 x	ET-321HS3330B-2995-483/S1	Solenoid valve
	3 x	ET-MANO.063SR711C	Pressure gauge		2 x	ET-321HS3330C-2995-483/S1	Solenoid valve
	1 x	ET-DRM.G08-AIRCOM-5	Pressure reducer		2 x	RHD28L0.2BCF	no return valve
	5 x	RHD12L0.2BCF	no return valve		3 x	ET-MANO.063SR711C	Pressure gauge
				1 x	ET-DRM.G08-AIRCOM-5	Pressure reducer	
				5 x	RHD12L0.2BCF	no return valve	

HDK-MT 100 & 350 bar Series



GENERATION D2

from 2014 to the present day

For the maintenance of this product range, 12 and 24 month service-kits are required, together with other components referenced below. Furthermore a 24 month maintenance interval requires a DESMIX-package (Adsorption material package) containing all filling-materials for the dryer model in question.

12 / 36 Month interval

Material required: Service-Kit, Silencer, Pre- and after filterelements, dewpointsensor ZHM100/450

Service-kit contents: See table on next page

HDK-MT	Material required – PMC Order No.			Options – PMC Order No.	
Product code	Service-kit	Filter-element	Silencer	Others	
HDK-MT 15/100 & 350	SKH15-H30/D2/12 see pag. 78/79 use Tools kits	Already included inside the servicekits, by additional need please see table on next page	SDD-15/600/AL	ZHM100/450	
HDK-MT 20/100 & 350					
HDK-MT 25/100 & 350					
HDK-MT 30/100 & 350					
HDK-MT 40/100 & 350	SKH40-H70/D2/12 see pag. 78/79 use Tools kits				
HDK-MT 50/100 & 350					
HDK-MT 70/100 & 350					

24 / 48 month interval

Material required: Service-Kit, Silencer, Pre- and after filterelements, replacement desiccant, dewpointsensor ZHM100/450

Service-kit contents: See table on next page

HDK-MT	Material required – PMC Order No.			Options – PMC Order No.	
Product code	Service-kit	Filter-element	Silencer	Others	
HDK-MT 15/100 & 350	SKH15-H30/D2/24 see pag. 78/79 use Tools kits	Already included inside the servicekits, by additional need please see table on next page	SDD-15/600/AL	ZHM100/450	
HDK-MT 20/100 & 350					
HDK-MT 25/100 & 350					
HDK-MT 30/100 & 350					
HDK-MT 40/100 & 350	SKH40-H70/D2/24 see pag. 78/79 use Tools kits				
HDK-MT 50/100 & 350					
HDK-MT 70/100 & 350					

HDK-MT 100 & 350bar Series

GENERATION D2
from 2014 to the present day



Contents DESMIX: Three layer desiccant charge (ceramic/silica gel/molecular sieve beads)

HDK-MT 100

HDK-MT 350

HDK-MT	PMC Order-No.	HDK-MT	PMC Order-No.	HDK-MT	PMC Order-No.	HDK-MT	PMC Order-No.
Product Code	DESMIX-package	Product Code	DESMIX-package	Product Code	DESMIX-package	Product Code	DESMIX-package
HDK-MT 15	H15/100/D2-DESMIX	HDK-MT 40	H40/100/D2-DESMIX	HDK-MT 15	H15/350/D2-DESMIX	HDK-MT 40	H40/350/D2-DESMIX
HDK-MT 20	H20/100/D2-DESMIX	HDK-MT 50	H50/100/D2-DESMIX	HDK-MT 20	H20/350/D2-DESMIX	HDK-MT 50	H50/350/D2-DESMIX
HDK-MT 25	H25/100/D2-DESMIX	HDK-MT 70	H70/100/D2-DESMIX	HDK-MT 25	H25/350/D2-DESMIX	HDK-MT 70	H70/350/D2-DESMIX
HDK-MT 30	H30/100/D2-DESMIX			HDK-MT 30	H30/350/D2-DESMIX		

Replacement filter elements for pre- and after filters

HDK-MT	PMC Order-No.		HDK-MT	PMC Order-No.	
Product code	Filter housing size	Element grade ZP, XP	Product code	Filter housing size	Element grade ZP, XP
HDK-MT 15	GH7	1140_	HDK-MT 40	GH9	2010_
HDK-MT 20	GH7	1140_	HDK-MT 50	GH9	2010_
HDK-MT 25	GH7	1140_	HDK-MT 70	GH9	2010_
HDK-MT 30	GH7	1140_			

The code spacing_ should contain the filter-element grade required.

Example: Filter GH7XP containing filter element 1140XP or filter GH9XP containing with filter element 2010XP.

Attention: Elements are already included inside service kit of generation D2.

HDK-MT 100 & 350 bar Series

GENERATION D2

from 2014 to the present day

For the maintenance of this product range, 12 and 24 month service-kits are required, together with other components referenced below. Furthermore a 24 month maintenance interval requires a DESMIX-package (Adsorption material package) containing all filling-materials for the dryer model in question.



Main content Service kits :

Service scope: valves HDK-MT 4 - 70 PN100/350 Generation 2



Parker Hannifin Manufacturing S.p.A.
Sede Legale: Via Privata Anichinide, 5 - 20090 Corsico (MI) Italy
Sede Operativa: Gas Separation and Filtration Division EMEA - Strada Zona Industriale, 4
35025 S. Girolamo di Po (PD) Italy
tel. +39 049 9711 2111 - fax +39 049 9701911
Web-site: www.parker.com/italy
e-mail: technical.support@hioscparker.com

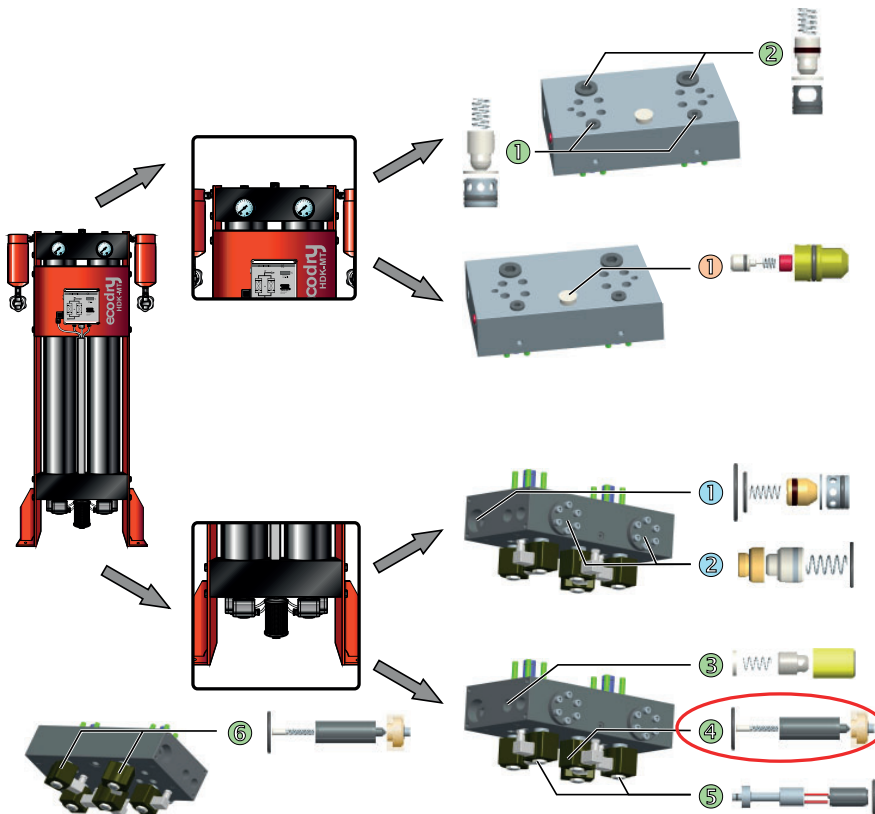

12 Month- SKH15-H30/D2/12, SKH40-H70/D2/12

- ① 2 x V3/V4 expansion valve (0352651)
- ② 2 x V1/V2 main inlet valve (0352649)

24 Month- SKH15-H30/D2/24, SKH40-H70/D2/24

- ③ 2 x check valve pressurization (0352650)
- ④ 1 x pilot valve pressurization Y5 (0352839)
- ⑤ 2 x pilot valve Y1/Y2 (0352653)
- ⑥ 2 x pilot valve Y3/Y4 (0352839)

Spare part ET-HDK-MT/2/VN

- ① 1 x needle valve - for all size (0353249)

Spare part

- ① 2 x check valve DN 6 (0352659)
- ② 2 x check valve DN 12 (0352656)



ENGINEERING YOUR SUCCESS.

HDK-MT 100 & 350bar Series

GENERATION D2
from 2014 to the present day



HDK-MT Special Tools

PMC order number: HDK-TOOL1

Benefits

- Necessary tool for HDK-MT
- Tools in a stabile case
- Support all works on the solenoid valve
- Fits on all valve blocks
- Perfect mounting
- Saves working time
- User manual included



This valve-mounting-tool-set includes five special tools of support all relevant maintenance works on the HDK-MT series solenoid valves. These high precision tools are made out of stainless steel. it gunrantees a save and successfull maintenance

PMC order number: HDK-TOOL2

Benefits

- Easy to handle
- 2 way usage
- Necessary tool for HDK, HDAM
- Fits all unit sizes
- Precise control behaviour
- Reduce working time

The Parker ZANDER vessel-lock-remover is needed for the dessicant change works on all vessel of the high pressure range from 100 to 350 bar. The tool fit's on all pressure vessel for the series HDK-MT. HDAM and HDA adsorber.

The HDK.TOOL2 allows an easy and save demounting (lift-up) and mounting (press-in) of the vessel-lock-piston

Service Bulletin

HDK-TOOL1
HDK-MT valve mounting tool set

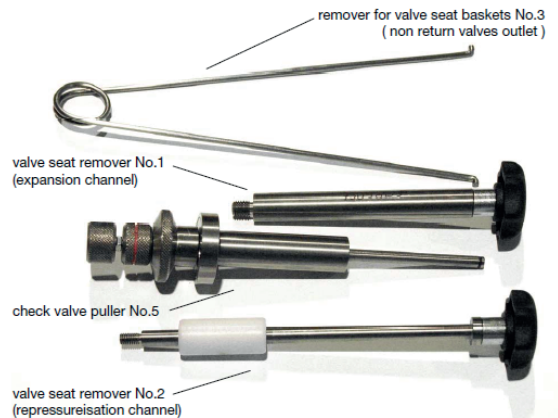

HDK-TOOL2
Vessel-Piston-Remover-Tool

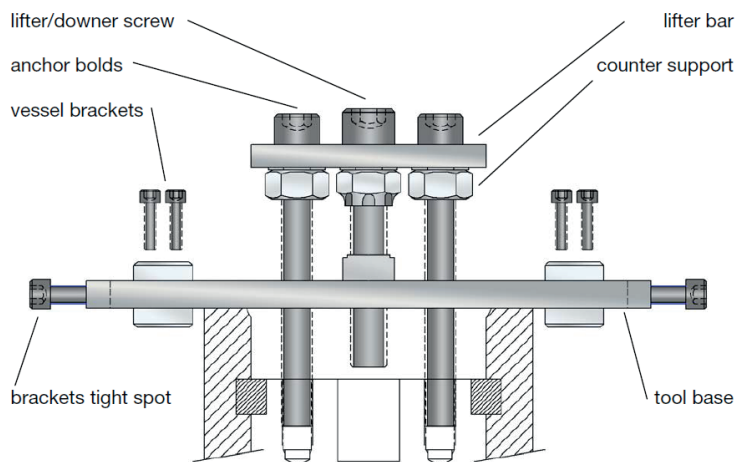

HDK-MT 100 & 350 bar Series



GENERATION D2
from 2014 to the present day



Additional repair kits all pressure stages:

Repair kits: Further wear part sets as required

For model	PMC Order no.	Service internal	Scope of supply
all	RKH15-H70/RV1-RV4	as required	Four check valves RV1-RV4
	RKESC-HDK-230-NH		Five solenoid coils 230V/50-60Hz
	RKESC-HDK-115-NH		Five solenoid coils 115V/50-60Hz
	RKH15-H70/PWS		Two vessel nozzles incl. o-rings

Further spare part as required

For model	PMC Order no.	Service internal	Scope of supply
all	SDD-15/600/AL	as required	Silencer
	ZHM100/450		Dew point sensor
	ET-HDK-MT/2/VN		Needle valve VN (for regeneration gas)
	ET-HDK-MT/2/MV-BLOCK		Solenoid valve block without coils
	ET-HDK-MT/2/RV-BLOCK		Check valve block without needle valve vn, without gauges
	ET-MANO.063MR0816		Gauge incl.seal

HDK-MT 100 & 350 bar Series

GENERATION D2
from 2014 to the present day



Accessories 100 & 350 bar series:

Accessories, lose or mounted ex works

Start-up device		
Suitable for model	PMC Order no.	Description
HDK-MT 15/100 up to HDK-MT 30/100	VASVPB/100/15	Pressure maintaining valve G1/2 PN100 incl. adjustable opening pressure incl. fitting and T-piece for regeneration gas back flow
HDK-MT 15/350 up to HDK-MT 30/350	VASVPB/450/15	Pressure maintaining valve G1/2 PN450 incl. adjustable opening pressure incl. fitting and T-piece for regeneration gas back flow
HDK-MT 40/100 up to HDK-MT 70/100	VASVPB/415/20	Pressure maintaining valve G3/4 PN415 incl. adjustable opening pressure incl. fitting and T-piece for regeneration gas back flow
HDK-MT 40/350 up to HDK-MT 70/350	VASVPB/415/20	Pressure maintaining valve G3/4 PN415 incl. adjustable opening pressure incl. fitting and T-piece for regeneration gas back flow
Time controlled drains for prefilter, various power supplies		
Suitable for model	PMC Order no.	Description
all	TRAP2/100-G230/P	Time controlled solenoid valve G1/4i, PN100, 2-55°C, 230 VAC, IP65
all	TRAP2/350-G230/P	Time controlled solenoid valve G1/4i, PN350, 2-55°C, 230 VAC, IP65
all	TRAP2/100-G115/P	Time controlled solenoid valve G1/4i, PN100, 2-55°C, 115 VAC, IP65
all	TRAP2/350-G115/P	Time controlled solenoid valve G1/4i, PN350, 2-55°C, 115 VAC, IP65
all	TRAP2/100-G24D/P	Time controlled solenoid valve G1/4i, PN100, 2-55°C, 24 VDC, IP65
all	TRAP2/350-G24D/P	Time controlled solenoid valve G1/4i, PN350, 2-55°C, 24 VDC, IP65
Differential pressure gauges for pre- and afterfilter		
Suitable for model	PMC Order no.	Description
all	HZD80/420RG	Calibrated analogue differential pressure gauge PN420
all	HZDE80/420RG	Calibrated analogue differential pressure gauge PN420 incl. reed contact (IP54)
Signal splitter		
Suitable for model	PMC Order no.	Description
all	VASMBS420	analogue output contact 4-20 mA for dew-point signal



HDK-MT 100, 250 & 350bar Series

GENERATION D1
from 2008 to 2014

For the maintenance of this product range, 12 and 24 month service-kits are required, together with other components referenced below. Furthermore a 24 month maintenance interval requires a DESPAC-package (Adsorption material package) containing all filling-materials for the dryer model in question.

12 / 36 Month interval

Material required: Service-Kit, Silencer, Pre- and after filterelements
 Service-kit contents: See table on next page
 Options: Dew-point sensor ZHM100/450

HDK-MT	Material required – PMC Order No.			Options – PMC Order No.	
Product code	Service-kit	Filter-element	Silencer	Others	
HDK-MT 4	HDK-MT12A see pag. 82/83 use Tools kits	see replacement filter elements on opposite page	SDD-15/600/AL	ZHM100/450	
HDK-MT 6					
HDK-MT10					
HDK-MT15					
HDK-MT20					
HDK-MT25					
HDK-MT30					
HDK-MT40					
HDK-MT50					
HDK-MT60					
HDK-MT70					

24 / 48 month interval

Material required: Service-Kit, Silencer, Pre- and after filterelements, replacement desiccant
 Service-kit contents: See table on next page
 Options: Dew-point sensor ZHM100/450

HDK-MT	Material required – PMC Order No.			Options – PMC Order No.	
Product code	Service-kit	Filter-element	Silencer	Others	
HDK-MT 4	HDK-MT24A see pag. 82/83 use Tools kits	see replacement filter elements on opposite page	SDD-15/600/AL	ZHM100/450	
HDK-MT 6					
HDK-MT10					
HDK-MT15					
HDK-MT20					
HDK-MT25					
HDK-MT30					
HDK-MT40					
HDK-MT50					
HDK-MT60					
HDK-MT70					

HDK-MT 100, 250 & 350bar Series

GENERATION D1
from 2008 to 2014



DESPACs / Replacement desiccant

24 month interval

Desiccant packs for HDK-MT 100 bar



Content DESPACs: Molecular sieve in 1 kg, 4 kg or 15 kg packs

Order-No.	Content	HDK-MT 4	HDK-MT 6	HDK-MT 10	HDK-MT 15	HDK-MT 20	HDK-MT 25	HDK-MT 30	HDK-MT 40	HDK-MT 50	HDK-MT 60	HDK-MT 70
DESPAC1MS	(1,7 kg)						1	1	1		1	
DESPAC4MS	(4 kg)	2	2	2	2	3		1	3	1	2	3
DESPAC15MS	(15 kg)						1	1	2	2	2	2

Desiccant packs for HDK-MT 250 & 350 bar

Content DESPACs: Molecular sieve in 1 kg, 4 kg or 15 kg packs

Order-No.	Content	HDK-MT 4	HDK-MT 6	HDK-MT 10	HDK-MT 15	HDK-MT 20	HDK-MT 25	HDK-MT 30	HDK-MT 40	HDK-MT 50	HDK-MT 60	HDK-MT 70
DESPAC1MS	(1,7 kg)	1	1	1	1	2	2		2	2		1
DESPAC4MS	(4 kg)	1	1	1	1	1	2	3		1	3	3
DESPAC15MS	(15 kg)								1	1	1	1

Replacement filter elements for pre- and after filters

HDK-MT	PMC Order-No.		HDK-MT	PMC Order-No.	
Product code	Filter housing size	Element grade ZP, XP	Product code	Filter housing size	Element grade ZP, XP
HDK-MT 4	G3	1050_	HDK-MT 30	G7	1140_
HDK-MT 6	G3	1050_	HDK-MT 40	G9	2010_
HDK-MT 10	G3	1050_	HDK-MT 50	G9	2010_
HDK-MT 15	G5	1070_	HDK-MT 60	G11	2020_
HDK-MT 20	G5	1070_	HDK-MT 70	G11	2020_
HDK-MT 25	G7	1140_			

The code spacing_ should contain the filter-element grade required. Example: Filter G3XP containing filter element 1050XP.



HDK-MT 100, 250 & 350bar Series

GENERATION D1
from 2008 to 2014

Main content Service kits :

Service scope: valves

HDK-MT 4 - 70 PN100/250/350 generation 1

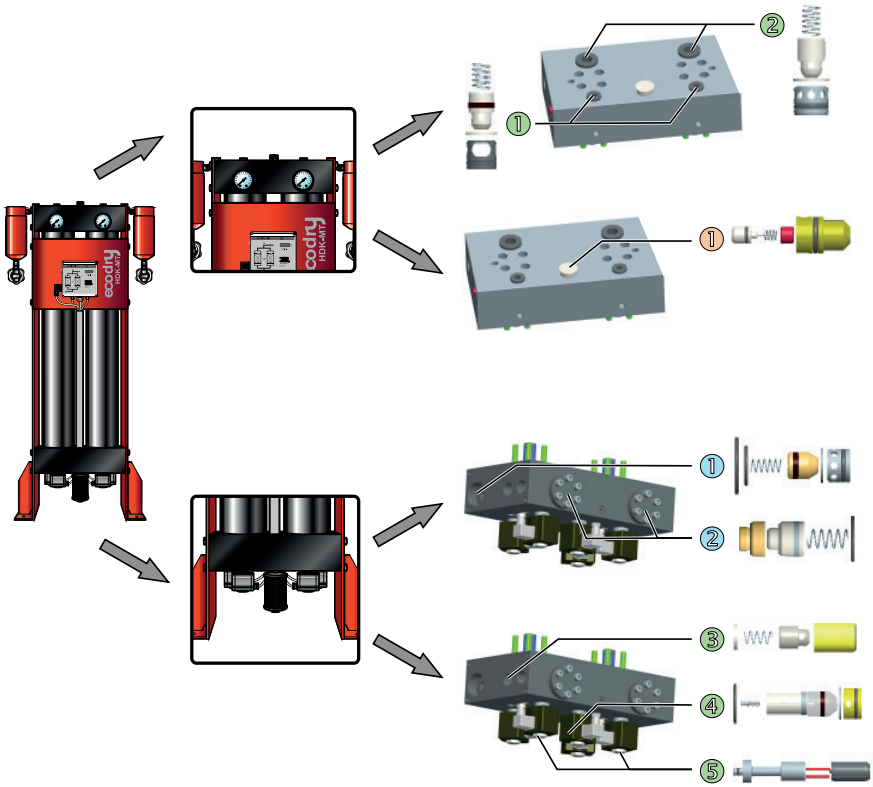

12 Month-Servicekit HDK-MT12A

- ① 2 x V3/V4 expansion valve (0352651)
- ② 2 x V1/V2 main inlet valve (0352649)

... and additional in 24 Month-Servicekit HDK-MT24A

- ① 2 x check valve DN 6 (0352659)
- ② 2 x check valve DN 12 (0352656)
- ③ 2 x check valve pressurization (0352650)
- ④ 1 x pilot valve pressurization Y5 (0352839)
- ⑤ 2 x pilot valve Y1/Y2 (0352653)
- ⑥ 2 x pilot valve Y3/Y4 (0352839)

Spare part ET-HDK-MT/2/VN

- ① 1 x needle valve - for all size (0352969)

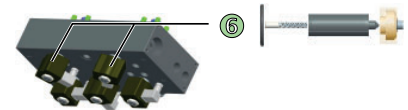

HDK-MT 100, 250 & 350bar Series



GENERATION D1
from 2008 to 2014

HDK-MT Special Tools

PMC order number: HDK-TOOL1

Benefits

- Necessary tool for HDK-MT
- Tools in a stabile case
- Support all works on the solenoid valve
- Fits on all valve blocks
- Perfect mounting
- Saves working time
- User manual included



This valve-mounting-tool-set includes five special tools of support all relevant maintenance works on the HDK-MT series solenoid valves. These high precision tools are made out of stainless steel. it gunnantees a save and successfull maintenance

PMC order number: HDK-TOOL2

Benefits

- Easy to handle
- 2 way usage
- Necessary tool for HDK, HDAM
- Fits all unit sizes
- Precise control behaviour
- Reduce working time

The Parker ZANDER vessel-lock-remover is needed for the dessicant change works on all vessel of the high pressure range from 100 to 350 bar. The tool fit's on all pressure vessel for the series HDK-MT. HDAM and HDA adsorber.

The HDK.TOOL2 allows an easy and save demounting (lift-up) and mounting (press-in) of the vessel-lock-piston

Service Bulletin

HDK-TOOL1
HDK-MT valve mounting tool set

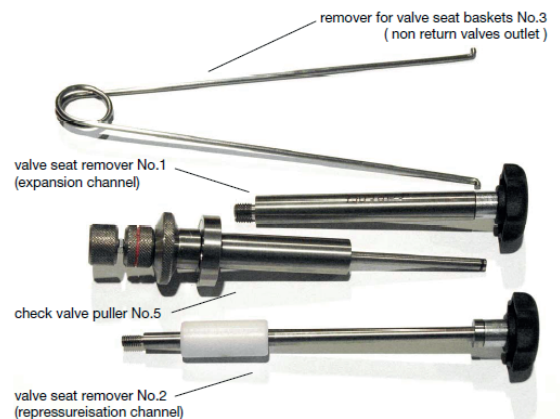

HDK-TOOL2
Vessel-Piston-Remover-Tool

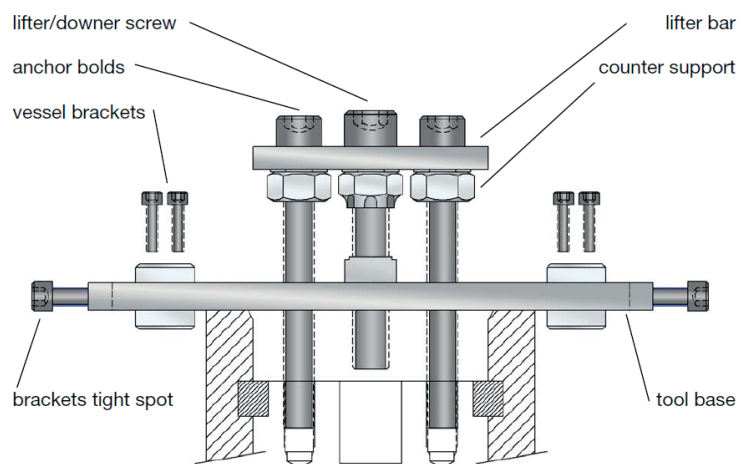

Controller upgrades



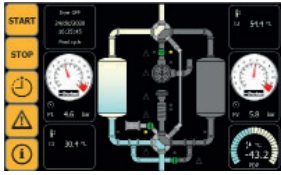

Retrofit Kits HCDC control

WVM adsorption dryers GENERATION 5 (VM5)

From 2021 to the present day

Excellent operatin overview with the colour TFT display of the new ZDMC2 PLC, which clearly and continuously shows values at a glance:

- Pressure per vessel
- Heating temperature
- Regeneration, air outlet
- Pressure dew point
- 2 times PT 100 (for inlet / outlet temperature, preset)
- 1 times 4-20 mA (frely selectable)

Available items:	PMC Order No. : 24V (DC)	Item description:

ON GOING

HCDC:features of the PLC

Dsplay	Touch screen (7" TFT 16:9 64k 800x480 colour)		
CPU			
Programming laguage			
Memory Storage			
Data recording			
Interfaces	Modbus RS485 (Modbus RJ45 (only usable as slave components i
Protocols	Modbus RS485 (configurable via touch screen) GSD file	Mobus TCP (Ethernet) (configurable via touch screen)	DV V0 (profibus)
Analogue inputs	Quantity: 4	4-20 mA PT100	2 times 1 time
Analogue outputs	Quantity: 2	4-20 mA	
Potential-free contacts	Quantity: 4	2 times internal allocation	
Digital inputs	Quantity: 16	24 V, non isolated	1 time
Dig. transistor outputs	Quantity: 16	Non-isolated 24 V, max. 0.5A	
Digital relay outputa	Quantity: 4	230 V. max. 3 A	



Retrofit Kits ZDMC2 control

WVM adsorption dryers GENERATION 4 (VM4)

From 2012 to 12/2020

Excellent operatin overview with the colour TFT display of the new ZDMC2 PLC, which clearly and continuously shows values at a glance:

- Pressure per vessel
- Heating temperature
- Regeneration, air outlet
- Pressure dew point
- 2 times PT 100 (for inlet / outlet temperature, preset)
- 1 times 4-20 mA (frely selectable)

Available items:	PMC Order No. : 24V (DC)	Item description:
ZDMC 2 Retrofit Kit	ET-ZDMC-2-24D/MB	Standard ZDMC 2 control with MODBUS RS485
ZDMC 2 Retrofit Kit /PB	ET-ZDMC-2/PB	ZDMC 2 control with PROFIBUS
Profibuscard Retrofit Kit	RK-ZDMC-2/PB	PROFIBUS card single (to upgrade ET-ZDMC-2-24D/MB)
Micro SD Card Kit	ET-ZDMC-2-MICRO-SD-CARD	Micro SD Card (2GB) single

ZDMC2:features of the PLC

Dsplay	Touch screen (TFT, 16-bit colour)		
CPU	Siemens 315 (only compatible with Parker components)		
Programming lagueage	STEP7 (Siemens Simatic Software)		
Memory Storage	24MB internal, 4GB micro SD memory card		
Data recording	Continuously in 5-minute steps for the prior weeks as binary code		
Interfaces	Modbus RS485 (configurable via touch screen)	Modbus RJ45 (configurable via touch screen)	only usable as slave components in Profibus (configurable via touch screen)
Protocols	Modbus RS485 (configurable via touch screen) GSD file	Mobus TCP (Ethernet) (configurable via touch screen)	DV V0 (profibus) (cofigurable via STEP7)
Analogue inputs	Quantity: 4	4-20 mA	2 times pressure B1/B2 1 time pressure dew point 1 time reserve
		PT100	1 time heater outlet 1 time regen, air outlet 2 times reserve
Analogue outputs	Quantity: 2	4-20 mA	2 configurable via touch panel
Potential-free contacts	Quantity: 4	2 times internal allocation	1 time collective fault 1 time operating notification
Digital inputs	Quantity: 16	24 V, non isolated	1 time vacuum pump error 1 time heater temp. limiter 1 time remote on/off 2 times regen. flaps open/closed 11 times reserve and preset options
Dig. transistor outputs	Quantity: 16	Non-isolated 24 V, max. 0.5A	2 times main valves 2 times regen, flaps open/closed 1 time pressure build-up valve open 1 time expansion valve open (amongst other)
Digital relay outputa	Quantity: 4	230 V. max. 3 A	1 time vacuum connect. 3 times heater stages 1-3 connect.

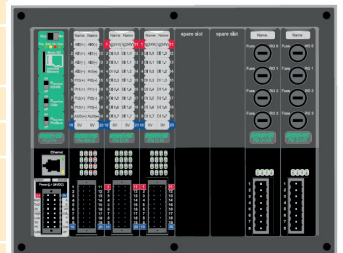

Retrofit Kits Multitronic control

All cold regenerated Zander adsorptiondryers

From 2003 until the present day



Benefits

- At least 20% energy savings
- Clearly structured display
- Dewpoint display
- Economy controller
- IP64 housing
- Fits all makes
- Fast installation
- Increase operational safety
- Floating alarm
- Service display
- Great versatility
- 100% compatible

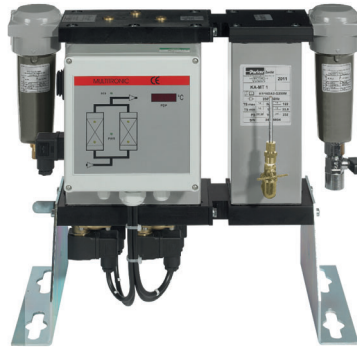

The Parker ZANDER MULTITRONIC controller is suitable for all heatless regenerated adsorption dryers. Guaranteed energy savings compared with conventional switch-over controllers.

Available items:	PMC Ordercodes: 115V / 230V (AC)	PMC Ordercodes: 24V (AC / DC)	Item description:
Multitronic Plus Retrofit Kit	UKMT-230-ZHM	UKMT-24D-ZHM	Multitronic with dewpoint sensor (4 Valves)
Multitronic Basic Retrofit Kit	UKMT-230	UKMT-24D	Multitronic standard (4 Valves)
Multitronic Plus 5 Retrofit Kit	UKMT-230-5-ZHM	UKMT-24D-5-ZHM	Multitronic for high pressure dryers with dewpoint sensor (5 Valves)
Multitronic Basic 5 Retrofit Kit	UKMT-230-5	UKMT-24D-5	Multitronic for high pressure dryers (5 Valves)
MBS420 (analogue output 4-20mA)	VASMBS420	VASMBS420	Add on board to have a analogue output 4-20 mA signal
ZHM100 Dewpoint Sensor	ZHM100/450	ZHM100/450	4-20 mA Sensor
Service Dongle	K-MT12A	K-MT12A	Service Dongle (Reset module multitronic control after 8000 running hours needed)

Picture shows: **UKMT-230-ZHM**



Picture shows: **VASMBS420**

Optional accessories

- MBS420 (plug-on analog output for 4-20 mA dewpoint reading)



Picture shows: **Service Dongle (K-MT12A)**



Picture shows: **Zander Service Kit**



Oil-Vapour Adsorbers

AK, AKM, AKN Series





AKM 1-8 Series

GENERATION 3 (OIL-X filter)

from 01/2019

For the maintenance of this product range, a 12-month service-kit and a DESPAC-package are required. When the oil-control indicator shows that activated carbon replacement is required or at least after 12 months operation, this must be carried out. Independent of the level of discolouration in the indicator-tube (P02/ZR), the oil-control indicator must also be replaced.

12 month interval

Material required: Service-kit, DESPAC-package(s)
 Service-kit contents: Element for post-filter (Housing-body O-ring included), 2 x perforated screen with foamed-on gasket
 DESPAC-package contents: Activated carbon available in 3 kg & 10 kg containers
 Options: Indicator-tube P02/ZR

AKM	Material required - PMC Order-No.			Options - PMC Order-No.	
	Product Code	Service-kit	DESPAC	Quantity	Others
AKM 1	SKA1-A4/3	DESPAC3AK	1	P02/ZR	
AKM 2	SKA1-A4/3	DESPAC3AK	1		
AKM 3	SKA1-A4/3	DESPAC3AK	1		
AKM 4	SKA1-A4/3	DESPAC3AK	1		
AKM 6	SKA6-A7/3	DESPAC3AK	2		
AKM 7	SKA6-A7/3	DESPAC3AK	2		
AKM 8	SKA8/3	DESPAC10AK	1		

Replacement filter-elements for standard post-filter

AKM	Material required - PMC Order-No.	
Product Code	Filter Element	Element grade AO
AKM 1	P010	AO
AKM 2	P010	AO
AKM 3	P010	AO
AKM 4	P010	AO
AKM 6	P015	AO
AKM 7	P015	AO
AKM 8	P020	AO

Loose accessories

AKM	PMC Order-No.	Use
AKM 1 to AKM 4	VASVPB/K1-K4/08	Starting device G1/4i
AKM 6 to AKM 7	VASVPB/K6-K7/15	Starting device G1/2i
AKM 8	VASVPB/K8/20	Starting device G3/4i

AKM 1-8 Series

GENERATION 2

from 07/2011 to 12/2018

For the maintenance of this product range, a 12-month service-kit and a DESPAC-package are required. When the oil-control indicator shows that activated carbon replacement is required or at least after 12 months operation, this must be carried out. Independent of the level of discolouration in the indicator-tube (P02/ZR), the oil-control indicator must also be replaced.

12 and 36 month interval

Material required: Service-kit, DESPAC-package(s)
 Service-kit contents: Element for post-filter (Housing-body O-ring included), 2 x perforated screen with foamed-on gasket
 DESPAC-package contents: Activated carbon available in 3 kg & 10 kg containers
 Options: Indicator-tube P02/ZR

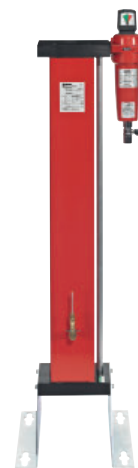

AKM	Material required - PMC Order-No.			Options - PMC Order-No.	
	Product Code	Service-kit	DESPAC	Quantity	Others
AKM 1	SKA1-A4	DESPAC3AK	1	P02/ZR	
AKM 2	SKA1-A4	DESPAC3AK	1		
AKM 3	SKA1-A4	DESPAC3AK	1		
AKM 4	SKA1-A4	DESPAC3AK	1		
AKM 6	SKA6-A7	DESPAC3AK	2		
AKM 7	SKA6-A7	DESPAC3AK	2		
AKM 8	SKA8	DESPAC10AK	1		

Replacement filter-elements for standard post-filter (Contained in the service-package)

AKM	Material required - PMC Order-No.	
	Product Code	Element grade V, ZP, XP, A
AKM 1	GL2	CP1008ZL
AKM 2	GL2	CP1008ZL
AKM 3	GL2	CP1008ZL
AKM 4	GL2	CP1008ZL
AKM 6	GL5	CP2010ZL
AKM 7	GL5	CP2010ZL
AKM 8	GL7	CP2020ZL

Loose accessories

AKM	PMC Order-No.	Use
AKM 1 to AKM 4	VASVPB/K1-K4/08	Starting device G1/4i
AKM 6 to AKM 7	VASVPB/K6-K7/15	Starting device G1/2i
AKM 8	VASVPB/K8/20	Starting device G3/4i

AKM 1-8 Series

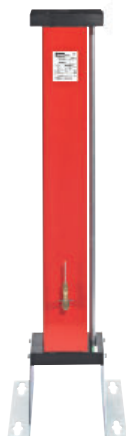

GENERATION 1

from 07/2003 to 06/2011

For the maintenance of this product range, a 12-month service-kit and a DESPAC-package are required. When the oil-control indicator shows that activated carbon replacement is required or at least after 12 months operation, this must be carried out. Independent of the level of discolouration in the indicator-tube (P02/ZR), the oil-control indicator must also be replaced.

12 and 36 month interval

Material required: Service-kit, DESPAC-package(s)
 Service-kit contents: Element for post-filter (Housing-body O-ring included), 2 x perforated screen with foamed-on gasket
 DESPAC-package contents: Activated carbon available in 3 kg & 10 kg containers
 Options: Indicator-tube P02/ZR

AKM	Material required - PMC Order-No.			Options - PMC Order-No.	
	Product Code	Service-kit	DESPAC	Quantity	Others
AKM 1	RKA1-A4	DESPAC3AK	1	P02/ZR	
AKM 2	RKA1-A4	DESPAC3AK	1		
AKM 3	RKA1-A4	DESPAC3AK	1		
AKM 4	RKA1-A4	DESPAC3AK	1		
AKM 6	RKA6-A8	DESPAC3AK	2		
AKM 7	RKA6-A8	DESPAC3AK	2		
AKM 8	RKA6-A8	DESPAC10AK	1		

Replacement filter-elements for standard post-filter

AKM	Material required - PMC Order-No.	
	Product Code	Filter housing size
AKM 1	G2	1030ZP
AKM 2	G2	1030ZP
AKM 3	G2	1030ZP
AKM 4	G2	1030ZP
AKM 6	G5	1070ZP
AKM 7	G5	1070ZP
AKM 8	G7	1140ZP

AKM 5-115 Series

GENERATION 0
up to 07/2003



For the maintenance of this product range, a 12-month service-kit and a DESPAC-package are required. When the oil-control indicator shows that activated carbon replacement is required or at least after 12 months operation, this must be carried out. Independent of the level of discolouration in the indicator-tube (P02/ZR), the oil-control indicator must also be replaced.

12 and 36 month interval

Material required:	Service-kit, DESPAC-package(s)
Service-kit	2 x perforated screen with foamed-on gasket
DESPAC-package contents:	Activated carbon available in 3 kg & 10 kg containers
Options:	Indicator-tube P02/ZR

AKM	Material required - PMC Order-No.			Options - PMC Order-No.	
Product Code	Service-kit	DESPAC	Quantity	Others	
AKM 5	RKA1-A4	DESPAC3AK	1 X	P02/ZR	
AKM 10	RKA1-A4	DESPAC3AK	1 X		
AKM 25	RKA1-A4	DESPAC3AK	1 X		
AKM 35	RKA1-A4	DESPAC3AK	1 X		
AKM 75	AKMKIT2	DESPAC3AK	2 X		
AKM 95	AKMKIT2	DESPAC3AK	2 X		
AKM 115	AKMKIT2	DESPAC10AK	1 X		

Replacement filter-elements for standard post-filter

AKM	Material required - PMC Order-No.	
Product Code	Filter housing size	Element grade V, ZP, XP, A
AKM 5	G2	1030ZP
AKM 10	G2	1030ZP
AKM 25	G2	1030ZP
AKM 35	G2	1030ZP
AKM 75	G5	1070ZP
AKM 95	G5	1070ZP
AKM 115	G7	1140ZP

AKM 10-95 Series

GENERATION 3 (OIL-X filter)

from 01/2019

For the maintenance of this product range, a filter element for the installed post-filter and a DESPAC-package are required. When the oil-control indicator shows that activated carbon replacement is required or at least after 12 months operation, this must be carried out. Independent of the level of discolouration in the indicator-tube (P02/ZR), the oil-control indicator must also be replaced. When required, it may be necessary to clean or eventually replace the flow-distributor.

12 month interval

Material required: Filter-element, DESPAC-package(s)
 DESPAC-package contents: Activated carbon available in 3 kg & 10 kg containers
 Options: Indicator-tube P02/ZR, Flow-distributor



AKM	Material required - PMC Order-No.				Options - PMC Order-No.	
	Product Code	Post-filter	Filter-element for post-filter	DESPAC	Quantity	Indicator tube
AKM 10	AOP025EGMI	P025AA	DESPAC10AK	1	P02/ZR	RKSCD-G40/16/AL
AKM 15	AOP025EGMI		DESPAC3AK	1		
AKM 20	AOP025EGMI		DESPAC10AK	1		
			DESPAC3AK	2		
AKM 25	AOP030EGMI	P030AA	DESPAC10AK	1		
			DESPAC3AK	2		
AKM 35	AOP030EGMI		DESPAC10AK	3		RKSCD-G40/16/AL
AKM 45	AOP035EGMI		P035AA	DESPAC3AK		
		DESPAC10AK		3		
AKM 60	AOP040EGMI	P040AA	DESPAC10AK	5		
AKM 75	AOP040EGMI		DESPAC10AK	7		
AKM 95	AOP045EGMI	P045AA	DESPAC10AK	9		

AKM 10-95 Series

GENERATION 2

from 07/2011 to 12/2018



For the maintenance of this product range, a filter element for the installed post-filter and a DESPAC-package are required. When the oil-control indicator shows that activated carbon replacement is required or at least after 12 months operation, this must be carried out. Independent of the level of discolouration in the indicator-tube (P02/ZR), the oil-control indicator must also be replaced. When required, it may be necessary to clean or eventually replace the flow-distributor.

12 and 36 month interval

Material required: Filter-element (Housing-body O-ring included), DESPAC-package(s)
 DESPAC-package contents: Activated carbon available in 3 kg & 10 kg containers
 Options: Indicator-tube P02/ZR, Flow-distributor

AKM	Material required - PMC Order-No.			Options - PMC Order-No.	
	Product Code	Filter-element for post-filter	DESPAC	Quantity	Others
AKM 10	CP3025ZL	DESPAC10AK	1	P02/ZR	RKSCD-G40/16/AL
AKM 15	CP3025ZL	DESPAC3AK DESPAC10AK	1 1		
AKM 20	CP3025ZL	DESPAC3AK DESPAC10AK	2 1		
AKM 25	CP3040ZL	DESPAC3AK DESPAC10AK	1 2		
AKM 35	CP3040ZL	DESPAC10AK	3		RKSCD-G40/16/AL
AKM 45	CP4040ZL	DESPAC3AK DESPAC10AK	1 3		
AKM 60	CP4050ZL	DESPAC10AK	5		
AKM 75	CP4050ZL	DESPAC10AK	7		
AKM 95	CP4065ZL	DESPAC10AK	9		RKSCD-G50/16/AL



AK 10-95 Series

GENERATION 1

from 07/2007 to 06/2011

For the maintenance of this product range, a filter element for the installed post-filter and a DESPAC-package are required. When the oil-control indicator shows that activated carbon replacement is required or at least after 12 months operation, this must be carried out. Independent of the level of discolouration in the indicator-tube (P02/ZR), the oil-control indicator must also be replaced. When required, it may be necessary to clean or eventually replace the flow-distributor.

12 month interval

Material required: Filter-element, DESPAC-package(s)
 DESPAC-package contents: Activated carbon available in 3 kg & 10 kg containers
 Options: Indicator-tube P02/ZR, Flow-distributor

AK Product Code	Material required – PMC Order No.		Options - PMC Order-No.	
	DESPAC	Quantity	Others	Flow-distributor
AK 10	DESPAC10AK	1	P02/ZR	RKSCD-G40/16/AL
AK 15	DESPAC3AK	1		
	DESPAC10AK	1		
AK 20	DESPAC3AK	2		
	DESPAC10AK	1		
AK 25	DESPAC3AK	1		
	DESPAC10AK	2		
AK 35	DESPAC10AK	3		RKSCD-G40/16/AL
AK 45	DESPAC3AK	1		
	DESPAC10AK	3		
AK 60	DESPAC10AK	5		
AK 75	DESPAC10AK	7	RKSCD-G50/16/AL	
AK 95	DESPAC10AK	9		

Replacement filter elements for pre- and after filters

AK	Options - PMC Order-No.		AK	Options - PMC Order-No.	
Product code	Filter housing size	Element grade V, ZP, XP, A	Product code	Filter housing size	Element grade V, ZP, XP, A
AK 10	G9	2010ZP	AK 45	G12	2030ZP
AK 15	G9	2010ZP	AK 60	G13	2050ZP
AK 20	G11	2020ZP	AK 75	G14	3050ZP
AK 25	G12	2030ZP	AK 95	G14	3050ZP
AK 35	G12	2030ZP			

AKN 200-1400 Series

GENERATION 0
up to 06/2007



For the maintenance of this product range, a filter element for the installed post-filter and a DESPAC-package are required. When the oil-control indicator shows that activated carbon replacement is required or at least after 12 months operation, this must be carried out. Independent of the level of discolouration in the indicator-tube (P02/ZR), the oil-control indicator must also be replaced. When required, it may be necessary to clean or eventually replace the flow-distributor.

12 month interval

Material required: Filter-element, DESPAC-package(s)
 DESPAC-package contents: Activated carbon available in 3 kg & 10 kg containers
 Options: Indicator-tube P02/ZR, Flow-distributor

AKN Product Code	Material required – PMC Order No.		Options - PMC Order-No.
	DESPAC	Quantity	Others
AKN 200	DESPAC3AK	1	P02/ZR
	DESPAC10AK	1	
AKN 300	DESPAC3AK	2	
	DESPAC10AK	1	
AKN 400	DESPAC3AK	1	
	DESPAC10AK	2	
AKN 500	DESPAC10AK	3	
AKN 600	DESPAC3AK	1	
	DESPAC10AK	3	
AKN 800	DESPAC10AK	5	
AKN 1150	DESPAC10AK	7	
AKN 1400	DESPAC10AK	9	

Replacement filter elements for pre- and after filters

AKN Product code	Options - PMC Order-No.		K-MT Product code	Options - PMC Order-No.	
	Filter housing size	Element grade VL, ZL, XL, A		Filter housing size	Element grade VL, ZL, XL, A
AKN 200	G9	2010ZP	AKN 600	G12	2030ZP
AKN 300	G9	2010ZP	AKN 800	G13	2050ZP
AKN 400	G11	2020ZP	AKN 1150	G13	2050ZP
AKN 500	G11	2020ZP	AKN 1400	G14	3050ZP



AK 120-600 Series AKN 2000-10000 Series

GENERATION 2

For the maintenance of this product range, a filter element for the installed post-filter and a DESPAC-package are required. When the oil-control indicator shows that activated carbon replacement is required or at least after 12 months operation, this must be carried out. Independent of the level of discolouration in the indicator-tube (P02/ZR), the oil-control indicator must also be replaced. When required, it may be necessary to clean or eventually replace the flow-distributor.

12 month interval

Material required: Filter-element, GASKIT (4 x flat-gaskets), DESPAC-package(s)
 DESPAC-packages contents: Activated carbon available in 3 kg, 10 kg or 90 kg containers, Filler in 10 kg containers.
 Options: Indicator-tube P02/ZR, Flow-distributor

AK/AKN	Material required – PMC Order No.		Options - PMC Order-No.		
	DESPAC	Quantity	Others	Flow-distributor	
AK 120 AKN 2000	DESPAC3AK	2	P02/ZR	RKSCD-F50/16/VA GASKIT 50	
	DESPAC90AK	1			
	DESPAC10FD	3			
AK 150 AKN 2600	DESPAC10AK	4		RKSCD-F65/16/VA GASKIT 65	
	DESPAC90AK	1			
	DESPAC10FD	3			
AK 200 AKN 3100	DESPAC90AK	2			RKSCD-F80/16/VA GASKIT 80
	DESPAC10FD	4			
AK 250 AKN 3800	DESPAC10AK	3			
	DESPAC90AK	2			
	DESPAC10FD	5			
AK 300 AKN 5000	DESPAC10AK	7		RKSCD-F125/16/VA GASKIT 125	
	DESPAC90AK	2			
	DESPAC10FD	6			
AK 380 AKN 6000	DESPAC10AK	5			
	DESPAC90AK	3			
	DESPAC10FD	7			
AK 500 AKN 8000	DESPAC10AK	7			
	DESPAC90AK	4			
	DESPAC10FD	8			
AK 600 AKN 10000	DESPAC10AK	8			
	DESPAC90AK	5			
	DESPAC10FD	10			

Replacement filter-elements for recommended post-filter

PMC Order No.		PMC Order No.		PMC Order No.			PMC Order No.		
Product Code	element-Code	Product Code	element-Code	Product Code	element-Code	Quantity	Product Code	element-Code	Quantity
Element Grade V, ZP, XP		Element Grade VL, ZL, XL		Element Grade V, ZP, XP			Element Grade V, ZP, XP		
G12_	2030_	GL12_	CP4040_	F14_	3050_	1	F40_	3075_	4
G13_	2050_	GL13_	CP4050_	F17_	3075_	1	F60_	3075_	6
G14_	3050_	GL14_	CP4065_	F19_	5075_	1	F80_	3075_	8
G17_	3075_	GL17_	CP5065_	F20_	3075_	2	F100_	3075_	10
G18_	5060_	GL19_	CP5080_	F30_	3075_	3	F120_	3075_	12
G19_	5075_								

The code spacing_ should contain the filter-element grade required.

Example: Filter G14XP containing filter-element 3050XP or filter F19XP containing filter-element 5075XP.

The code spacing_ should contain the filter-element grade required.

Example: Filter GL14XL containing filter-element CP4065XL or filter F19XP containing filter-element 5075XP.



ED 3000 Series

Condensate drains

For the maintenance of this product range, 12, 24, 36 and 48 month service-kits are required together with other components as referenced below.

Interval 12, 24, 36 and 48 month

Material required: Service-kit
 Service-kit contents: Membrane, o-rings, dirt-sieve, valve piston, valve spring, condensate outlet
 Options: Hose fitting.

ED3000 Serie	Material required - PMC Order-No.	Options - PMC Order-No.
Typ	Service-kit	Others
ED3002-3100	SKED3000	ED3-KOND.AUSLAS



ED 4100 Series

Condensate drains

For the maintenance of this product range ED4100, no servicekit is required. If needed a defined repairkit can be provided with components as referenced below.

Interval: Only if needed

Material required: Repairkit
 Repairkit contents: 2/2 way solenoid valve, housing o-ring, electrical module o-ring and sensor module o-ring



Series ED4100	Material required - Order-No.
Type	Repairkit
ED4100	RKED4100/50

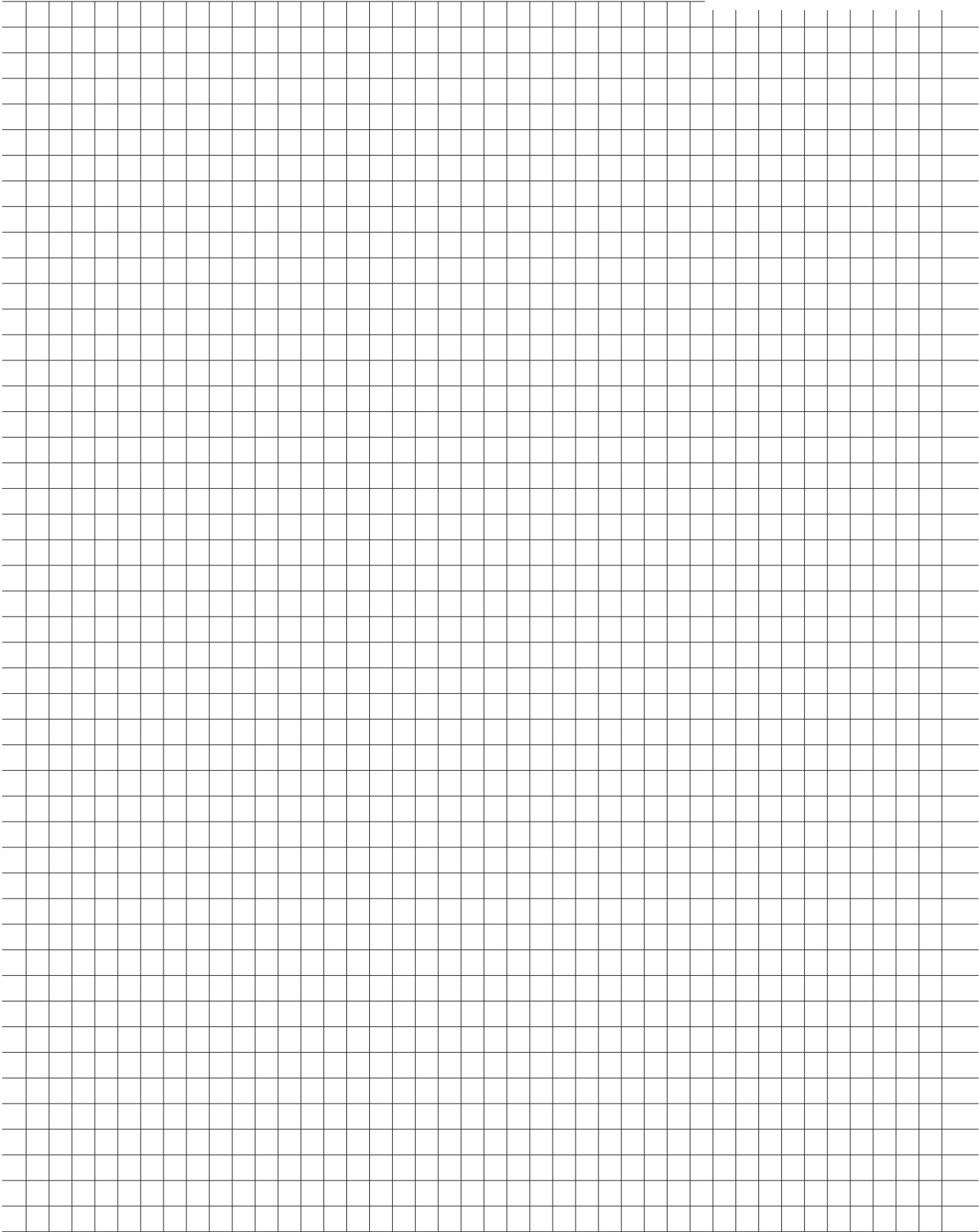

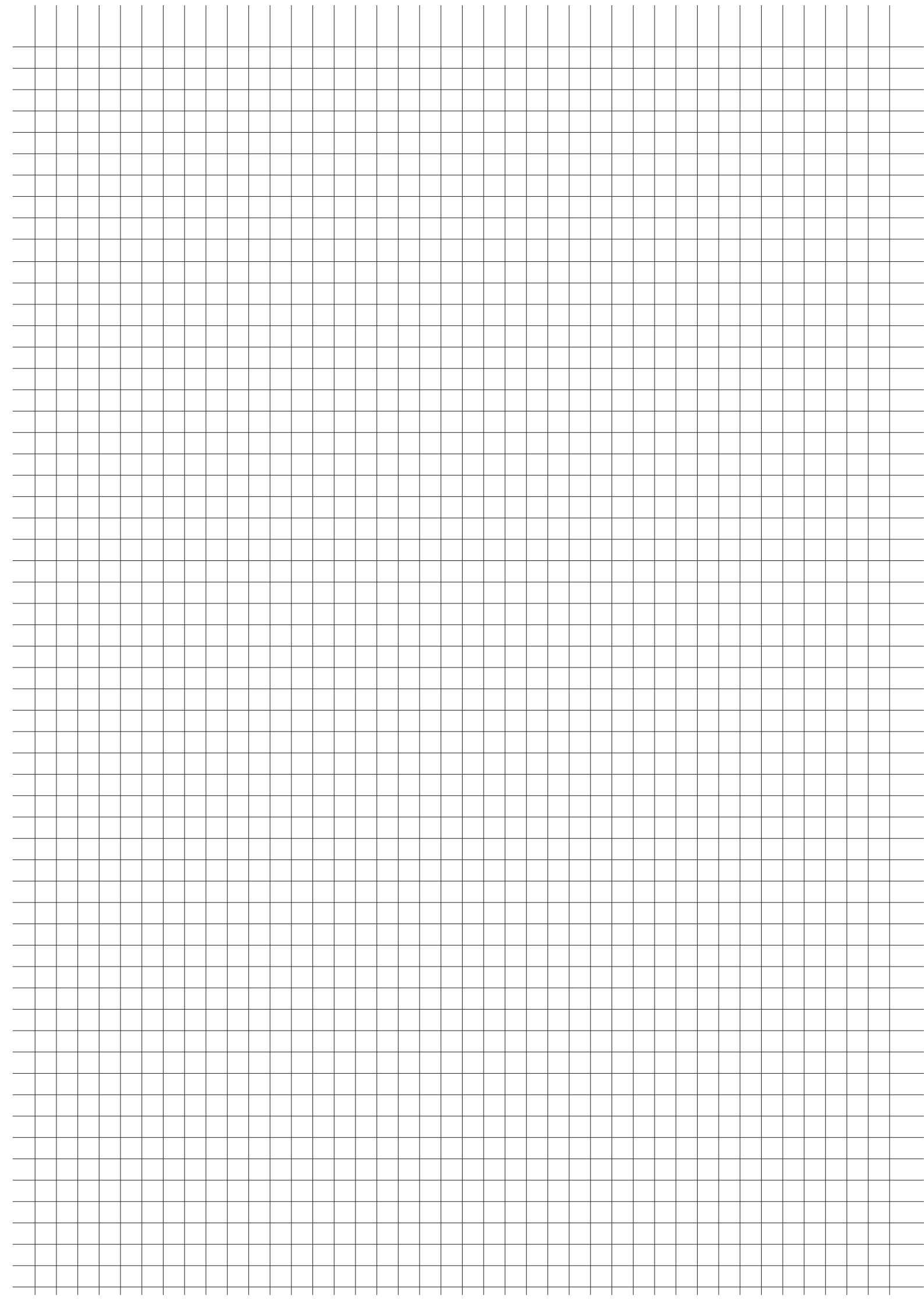

System planner for compressed air treatment - purity classes for compressed air

Compressed air generation

- Per day a compressor with 1000 m³/h sucks this quantity of contaminants:
- approx. 329 L water (humidity at 25 °C, 60 % RH)
 - millions solids > 2 µm
 - trillions solids < 2 µm
 - up to 72 g oil vapours (hydrocarbons)
- Per day a compressor supplies these 1000 m³/h compressed in the compressed air supply network with:
- 100 % RH (water saturated)
 - trillions solids < 2 µm
 - up to 72 g oil (for oil-free compressors) or approx. 24-4320 g oil (for oil-lubricated compressors) [in accordance with VDMA 15390:2014]

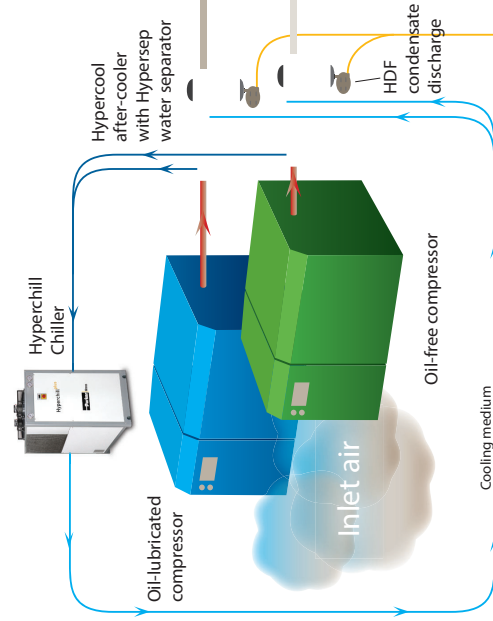

ISO 8573-1:2010

Class	Solid particulate Maximum number of particles per m ³		Water (vapour, aerosols, liquids) Content in mg/m ³	Oil (vapour, aerosols, liquids) Content in mg/m ³
	Particle size 0.1 - 0.5 µm	1 - 5 µm		
0	As specified between the supplier and equipment user (better than class 1)			
1	≤ 20,000	≤ 400	≤ 10	≤ 0,01
2	< 400,000	≤ 6,000	≤ 100	≤ 0,1
3	not agreed	≤ 90,000	≤ 20	≤ 1
4	not agreed	≤ 10,000	≤ ± 3	≤ 5
5	not agreed	≤ 100,000	≤ ± 7	not agreed

Reference conditions 1 bar, 20 °C, 0 % relative humidity; pressure dew-point at compressor end; pressure of 8 bar.

Centralised compressed air treatment

Note: The purity classes under ISO 8573-1 consider a specific measuring point in the compressed air supply grid. Components, such as pipes and isolation valves, influence the compressed air quality and must therefore be suitable for achieving a particular purity class. The treatment lines shown are therefore only provided for orientation.

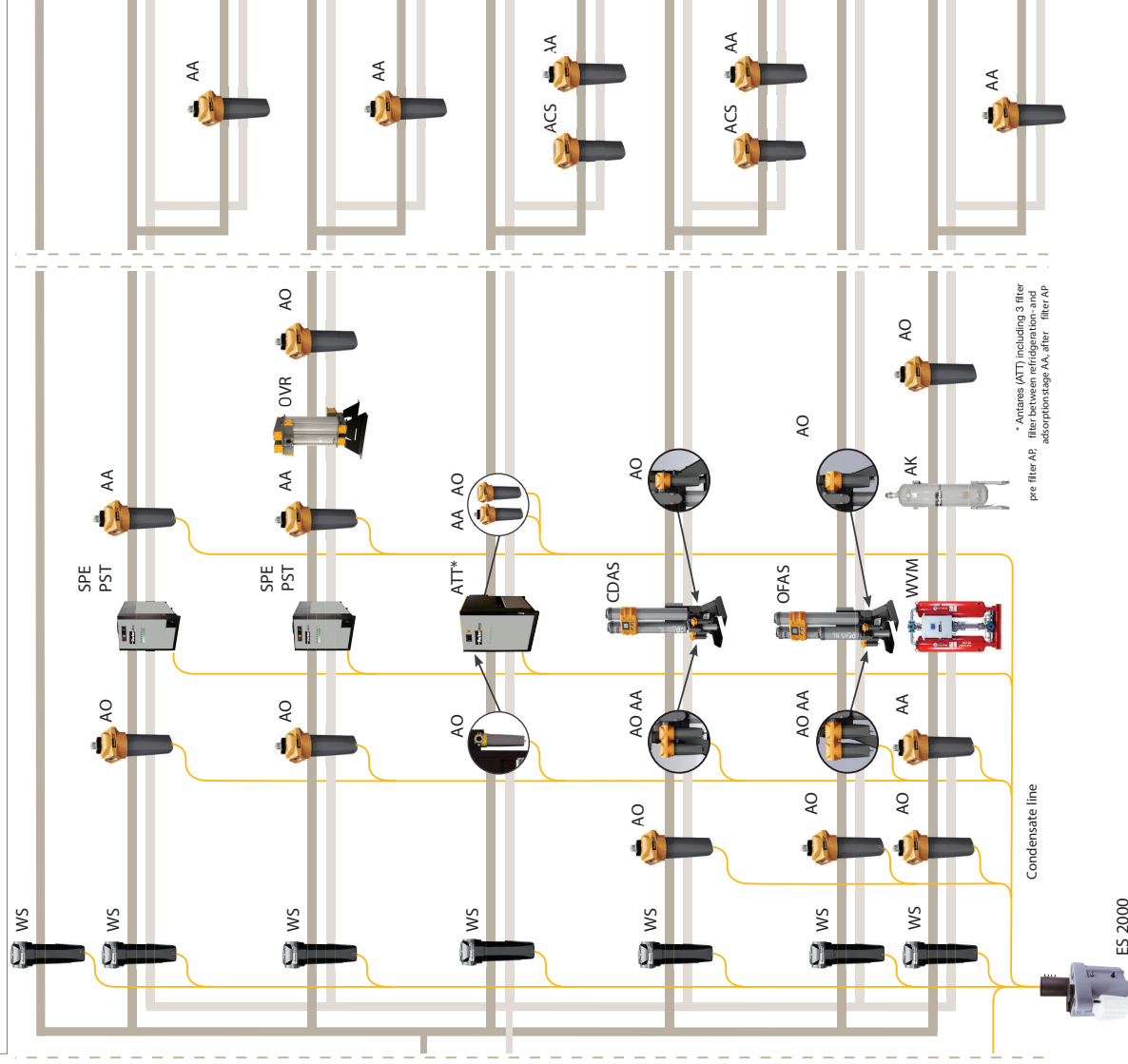

* Antares (ATT) including 8 filter pre filter AP, filter between refrigeration and adsorptionstage AA, after filter AP

Decentralised compressed air treatment

Purity classes acc. to ISO 8573-1:2010

Particles	Water and moisture	Total oil
–	7-8	–
2	4-6	2
1	4-6	2
2	4-6	1
1	4-6	1
2	1-4	2
1	1-4	1
2	1-2	2
1	1-2	1
2	1-2	1
2	1-2	1
1	1-2	1

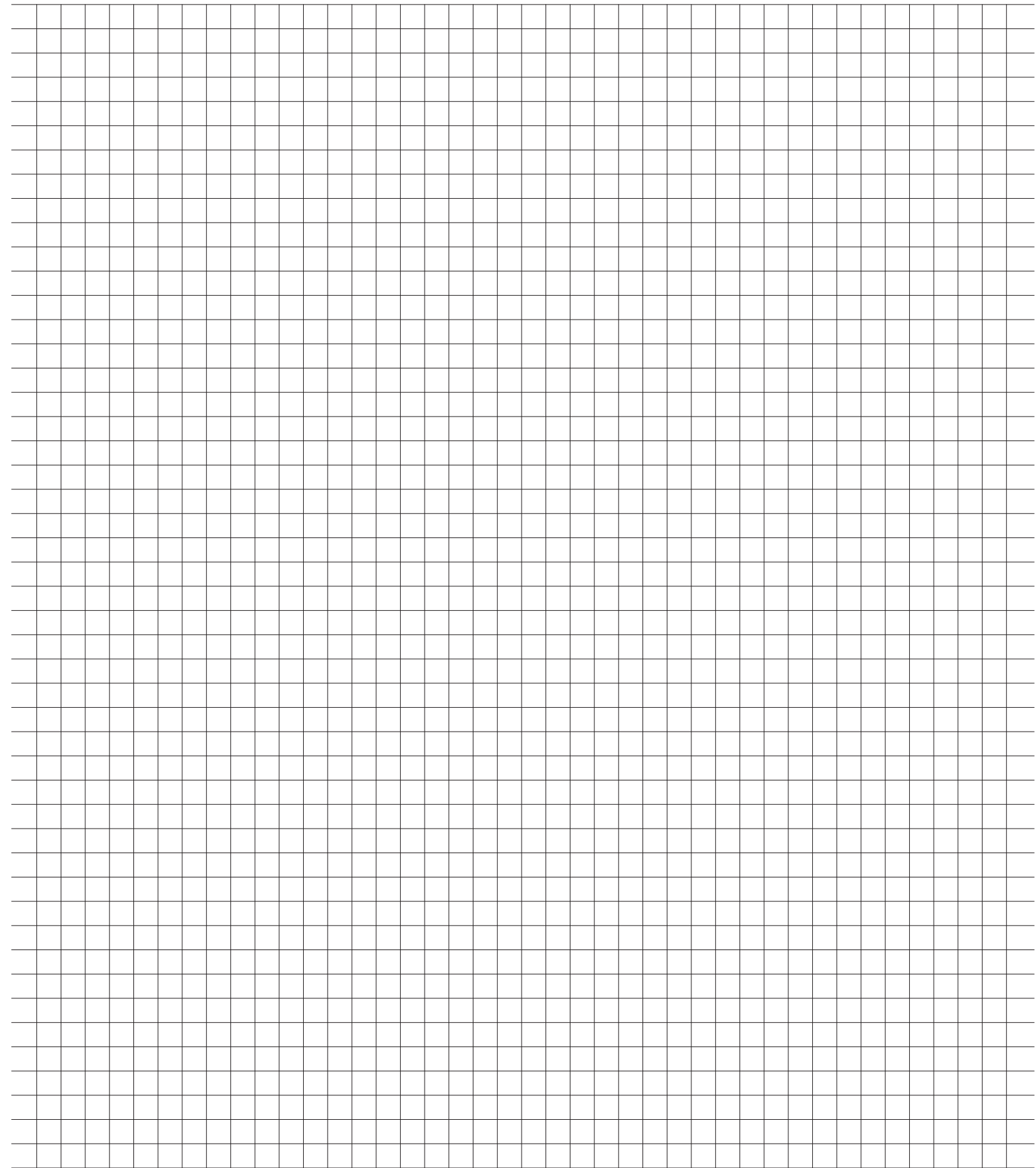

Parker Worldwide

Europe, Middle East, Africa

AE – United Arab Emirates, Dubai

Tel: +971 4 8127100
parker.me@parker.com

AT – Austria, Wiener Neustadt

Tel: +43 (0)2622 23501-0
parker.austria@parker.com

AT – Eastern Europe, Wiener Neustadt

Tel: +43 (0)2622 23501 900
parker.easteurope@parker.com

AZ – Azerbaijan, Baku

Tel: +994 50 2233 458
parker.azerbaijan@parker.com

BE/LU – Belgium, Nivelles

Tel: +32 (0)67 280 900
parker.belgium@parker.com

BG – Bulgaria, Sofia

Tel: +359 2 980 1344
parker.bulgaria@parker.com

BY – Belarus, Minsk

Tel: +48 (0)22 573 24 00
parker.poland@parker.com

CH – Switzerland, Etoy

Tel: +41 (0)21 821 87 00
parker.switzerland@parker.com

CZ – Czech Republic, Klecany

Tel: +420 284 083 111
parker.czechrepublic@parker.com

DE – Germany, Kaarst

Tel: +49 (0)2131 4016 0
parker.germany@parker.com

DK – Denmark, Ballerup

Tel: +45 43 56 04 00
parker.denmark@parker.com

ES – Spain, Madrid

Tel: +34 902 330 001
parker.spain@parker.com

FI – Finland, Vantaa

Tel: +358 (0)20 753 2500
parker.finland@parker.com

FR – France, Contamine s/Arve

Tel: +33 (0)4 50 25 80 25
parker.france@parker.com

GR – Greece, Athens

Tel: +30 210 933 6450
parker.greece@parker.com

HU – Hungary, Budaörs

Tel: +36 23 885 470
parker.hungary@parker.com

IE – Ireland, Dublin

Tel: +353 (0)1 466 6370
parker.ireland@parker.com

IL – Israel

Tel: +39 02 45 19 21
parker.israel@parker.com

IT – Italy, Corsico (MI)

Tel: +39 02 45 19 21
parker.italy@parker.com

KZ – Kazakhstan, Almaty

Tel: +7 7273 561 000
parker.easteurope@parker.com

NL – The Netherlands, Oldenzaal

Tel: +31 (0)541 585 000
parker.nl@parker.com

NO – Norway, Asker

Tel: +47 66 75 34 00
parker.norway@parker.com

PL – Poland, Warsaw

Tel: +48 (0)22 573 24 00
parker.poland@parker.com

PT – Portugal

Tel: +351 22 999 7360
parker.portugal@parker.com

RO – Romania, Bucharest

Tel: +40 21 252 1382
parker.romania@parker.com

RU – Russia, Moscow

Tel: +7 495 645-2156
parker.russia@parker.com

SE – Sweden, Spånga

Tel: +46 (0)8 59 79 50 00
parker.sweden@parker.com

SK – Slovakia, Banská Bystrica

Tel: +421 484 162 252
parker.slovakia@parker.com

SL – Slovenia, Novo Mesto

Tel: +386 7 337 6650
parker.slovenia@parker.com

TR – Turkey, Istanbul

Tel: +90 216 4997081
parker.turkey@parker.com

UA – Ukraine, Kiev

Tel: +48 (0)22 573 24 00
parker.poland@parker.com

UK – United Kingdom, Warwick

Tel: +44 (0)1926 317 878
parker.uk@parker.com

ZA – South Africa, Kempton Park

Tel: +27 (0)11 961 0700
parker.southafrica@parker.com

North America

CA – Canada, Milton, Ontario

Tel: +1 905 693 3000

US – USA, Cleveland

Tel: +1 216 896 3000

Asia Pacific

AU – Australia, Castle Hill

Tel: +61 (0)2-9634 7777

CN – China, Shanghai

Tel: +86 21 2899 5000

HK – Hong Kong

Tel: +852 2428 8008

IN – India, Mumbai

Tel: +91 22 6513 7081-85

JP – Japan, Tokyo

Tel: +81 (0)3 6408 3901

KR – South Korea, Seoul

Tel: +82 2 559 0400

MY – Malaysia, Shah Alam

Tel: +60 3 7849 0800

NZ – New Zealand, Mt Wellington

Tel: +64 9 574 1744

SG – Singapore

Tel: +65 6887 6300

TH – Thailand, Bangkok

Tel: +662 186 7000

TW – Taiwan, Taipei

Tel: +886 2 2298 8987

South America

AR – Argentina, Buenos Aires

Tel: +54 3327 44 4129

BR – Brazil, Sao Jose dos Campos

Tel: +55 800 727 5374

CL – Chile, Santiago

Tel: +56 2 623 1216

MX – Mexico, Toluca

Tel: +52 72 2275 4200